

## Operating Manual

HT 1300 solids module  
Automated solids analysis with  
multi N/C duo systems



---

Manufacturer                   Analytik Jena GmbH+Co. KG  
Konrad-Zuse-Straße 1  
07745 Jena / Germany  
Phone: +49 3641 77 70  
Fax: +49 3641 77 9279  
Email: info@analytik-jena.com

Technical Service               Analytik Jena GmbH+Co. KG  
Konrad-Zuse-Straße 1  
07745 Jena / Germany  
Phone: +49 3641 77 7407  
Fax: +49 3641 77 9279  
Email: service@analytik-jena.com



For a proper and safe use of this product follow the instructions. Keep the operating manual for future reference.

General Information           <http://www.analytik-jena.com>

Documentation Number        11-126.680 00 00 09 01

Edition                         B (07/2023)

Technical Documentation      Analytik Jena GmbH+Co. KG

© Copyright 2023, Analytik Jena GmbH+Co. KG

# Table of contents

<b>1 Basic information .....</b>	<b>5</b>
1.1 Information on the operating instructions.....	5
1.2 Intended use .....	6
<b>2 Security .....</b>	<b>7</b>
2.1 Safety labeling on the device .....	7
2.2 Requirements for the operating personnel.....	8
2.3 Safety instructions, transport and commissioning .....	8
2.4 Safety instructions: during operation .....	9
2.4.1 General.....	9
2.4.2 Safety instructions – protection against explosion and fire.....	9
2.4.3 Safety instructions – electrical equipment.....	9
2.4.4 Safety instructions for the operation of compressed gas containers and compressed gas systems.....	10
2.4.5 Handling of auxiliary and operating materials .....	10
2.4.6 Safety instructions – maintenance and repair .....	11
2.5 Behavior during emergencies .....	11
<b>3 Function and setup .....</b>	<b>12</b>
3.1 Function and measuring principle .....	12
3.2 Layout.....	13
3.3 Connection .....	16
3.4 Layout of multi N/C 2100S duo and multi N/C 3100 duo .....	17
<b>4 Installation and commissioning .....</b>	<b>20</b>
4.1 Environmental conditions .....	20
4.2 Power and gas supply.....	20
4.3 Device layout and space requirements.....	21
4.4 Unpacking and setting up the device.....	22
4.4.1 Setting up and connecting the solids module .....	23
4.4.2 Installing and adjusting the sampler .....	26
<b>5 Operation.....</b>	<b>30</b>
5.1 Switching the device on.....	30
5.2 Preparing the device for measurement with manual sample introduction .....	30
5.3 Performing a manual measurement .....	31
5.4 Preparing the device for measurement with automatic sample introduction .....	32
5.5 Performing a measurement with automatic sample introduction .....	35
5.6 Measurement cancelation during automatic sample introduction.....	37
<b>6 Troubleshooting .....</b>	<b>38</b>
6.1 Device error.....	38
6.2 Analytic problems .....	39
<b>7 Maintenance and care .....</b>	<b>40</b>
7.1 Overview of maintenance work .....	40
7.2 Replacing the halogen trap.....	40

---

7.3	Replacing the desiccant.....	41
7.4	Removing the combustion tube.....	42
7.5	Installing the combustion tube .....	44
7.6	Cleaning the dust trap .....	47
7.7	Replacing the particle filter.....	48
7.8	Checking the system for leaks.....	49
<b>8</b>	<b>Transport and storage.....</b>	<b>50</b>
8.1	Packing the solids module.....	50
8.2	Transport.....	51
8.3	Moving the device in the laboratory.....	51
8.4	Storage .....	52
<b>9</b>	<b>Disposal .....</b>	<b>53</b>
<b>10</b>	<b>Specifications.....</b>	<b>54</b>
10.1	Technical data.....	54
10.2	Standards and directives .....	55



# 1 Basic information

## 1.1 Information on the operating instructions

### Contents

The user manual describes the following device:

- HT 1300 solids module

These operating instructions provide information about the design and operation of the device and provide operating personnel the necessary know-how for the safe handling of the device and its components. Furthermore, the operating instructions include information on the maintenance and servicing of the device as well as hints on potential causes of malfunctions and their correction.

In addition, the operating instructions describe the automated solids analysis with the multi N/C 2100S duo and multi N/C 3100 duo modular measuring systems. Coupling of the solids module to the FPG 48 solids sampler is explained. Switching between liquid and solids methods is also explained.

### Conventions

Instructions for actions occurring in chronological order are numbered and combined into action units.

Warnings are indicated by a warning triangle and a signal word. The type, source and consequences of the hazard are stated together with notes on preventing the hazard.

Elements of the control and analysis program are indicated as follows:

- Program terms are in bold (e.g., the **System** menu).
- Menu items are separated by vertical lines (e.g., **System | Device**).

### Symbols and signal words used in this manual

The user manual uses the following symbols and signal words to indicate hazards or instructions. These warnings are always placed before an action.



### WARNING

Indicates a potentially hazardous situation which can cause death or very serious (possibly permanent) injury.



### CAUTION

Indicates a potentially hazardous situation which can cause slight or minor injuries.



### NOTICE

Provides information on potential material or environmental damage.

## 1.2 Intended use

The solids module is a powerful and compact device for the thermal digestion of solid, powder, paste, slurry or liquid samples. In conjunction with an analysis system detecting and analyzing the combustion gases the total carbon content (TC) and the content of organically bound carbon (TOC) of samples can be determined.

Due to its robust design, easy operation and high temperature range up to 1300 °C the solids module is versatile in application.

The solids module may only be used for the applications described in this user manual for solid, powder, paste, slurry or liquid samples. Any other use is considered to be improper use! Only the operator is liable for any damages that result from this.

In particular it is prohibited to use the solids module to combust liquids or substances that could form explosive mixtures. No concentrated acids may be incinerated with the solids module.

The device must only be used with oxygen as a carrier gas.

The operational safety of the solids module is only ensured if the solids module is used according to the information in this user manual.

## 2 Security

For your own safety and to ensure error-free and safe operation of the device, please read this chapter carefully before commissioning.







Observe all safety instructions listed in this user manual and all messages and information displayed on the monitor by the control and analysis software.

### 2.1 Safety labeling on the device

Warning and mandatory action labels have been attached to the device and must always be observed.

Damaged or missing warning and mandatory action labels can cause incorrect actions leading to personal injury or material damage. The labels must not be removed. Damaged warning and mandatory action labels must be replaced immediately!

The following warning and mandatory action labels have been attached to the device:

Warning symbol	Meaning	Remark
	Warning! Risk of dangerously high electrical voltage! Caution! The device remains energized when the main switch is switched off!	At the front of the solids module, below the main switch
	Warning against substances hazardous to health	At the front of the solids module, on the drying tube
	Warning about hot surface	At the front of the solids module, on the gas sluice
	Warning against a hazard location	At the front of the solids module, below the indicator elements
	Risk of crushing	On the solids sampler, on the sampler arm and on the boat carousel
Mandatory action and information labels	Meaning	Remark
	Before opening the device cover, disconnect the power plug	On the rear of the solids module
	Observe the operating manual	On the rear of the solids module
Caution! Do not operate the device without the working tube!	Operation without combustion tube will damage the device	At the front of the solids module, on the gas sluice

Mandatory action and information labels	Meaning	Remark
Caution! Fill with desiccant prior to the measurement!	Operation without desiccant will damage the connected detector	At the front of the solids module, on the drying tube

## 2.2 Requirements for the operating personnel

The device must only be operated by qualified specialist personnel instructed in the use of the device. This instruction also include teaching the contents of this user manual and of the user manuals of the connected system components. We recommend training by qualified employees of Analytik Jena or its representatives.

In addition to the safety instructions in this user manual, the general applicable safety and accident prevention regulations of the respective country the device is operated in must be observed and adhered to. The operator must ensure the latest version of these regulations.

The user manual must be accessible to the operating and service personnel.

## 2.3 Safety instructions, transport and commissioning

Incorrect installation can create serious hazards. This may result in electric shock and explosion if the gases are not connected correctly.

- Only the Analytik Jena customer service or specialist personnel trained and authorized by them is allowed to install and commission the device and its system components.
- Unauthorized assembly and installation is not permitted.

Insufficiently secured components pose a risk of injury.

- During transport, secure the device components as specified in these operating instructions.
- Loose parts must be removed from the system components and packed separately.

To prevent health damage, the following must be observed when moving the device in the laboratory (lifting and carrying):

- For safety reasons, two persons are required to transport the device who must hold the unit by either side of the equipment.
- The device does not have any carrying handles. Therefore the device must be gripped firmly with both hands at the lower end.
- Risk of damage to health due to improper decontamination! Perform a professional and documented decontamination of the device before returning it to Analytik Jena. The decontamination report is available from Service when registering the return. Without a completed decontamination report, the acceptance of the device will be refused. The sender may be liable for damage caused by inadequate decontamination of the device.

## 2.4 Safety instructions: during operation

### 2.4.1 General

The operator must make sure that the device and its safety equipment is in sound condition each time before starting up the device. This applies in particular after each modification or extension of the device or its repair.

Observe the following:

- The device may only be operated if all items of protective equipment (e.g. covers in front of electronic components) are in place, properly installed and fully operational.
- The sound condition of the protection and safety equipment must be checked regularly. Any defects must be corrected as soon as they occur.
- Protective and safety equipment must never be removed, modified or switched off during operation.
- Modifications, conversions and extensions to the device are only permitted after consultation with Analytik Jena. Unauthorized modifications can jeopardize the device's operational safety and may lead to limitations regarding the warranty and access to customer service.
- Free access to the main switch on the front of the device has to be ensured during operation.
- The ventilation equipment on the device must be in good working condition. Covered ventilation grilles or slots etc. may cause the device to break down or may cause damage to it.
- Never operate the combustion furnace of the solids module without combustion tube.
- The combustion furnace works at temperatures of up to HT 1300. Hot parts (combustion furnace, combustion tube, gas sluice, sample boats) may not be touched during or directly after the operation of the solids module.
- Prior to first commissioning and during commissioning after transport check that the top quartz glass wool plug has been removed from the dryer.
- Keep all combustible materials away from the device.
- Ensure that no liquid enters the interior of the device, for example at cable connections. There is a danger of electric shock.
- Risk of crushing at the FPG 48 sampler! The autosampler arm, the gripper and the boat carousel move during activation, initialization, adjustment and measurement operation. Keep an adequate distance to avoid having your hands crushed.

### 2.4.2 Safety instructions – protection against explosion and fire

The device may not be operated in an explosive environment.

Smoking or handling open flames are prohibited in the room in which the device is operated!

### 2.4.3 Safety instructions – electrical equipment

Work on electrical components of the solids module may only be carried out by a qualified electrician in accordance with the applicable electrical engineering rules. Life-threatening electrical voltages may occur in the left-hand side part of the solids module! Contact with live components may cause death, serious injury or painful electrical shock.

- The power plug must be connected to a proper power outlet to ensure that the device meets protection class I (ground connector). The device may only be connected to power sources whose nominal voltage is the same as that on the rating plate of the equipment. Do not replace the removable power cable of the device with a power cable that does not meet the specifications (with no protective ground conductor). Extensions of the supply cable are not permitted!
- The basic module and the system components may only be connected to the mains when they are switched off.
- Electrical connection cables between the basic module and the system components may only be connected or disconnected when the device is switched off.
- Work on the electronics may only be carried out by the customer service of Analytik Jena and specially authorized technicians.
- Before opening the device, the device must be switched off at the main switch and the power plug must be disconnected from the power outlet!

#### 2.4.4 Safety instructions for the operation of compressed gas containers and compressed gas systems

- The operating gases are taken from compressed gas containers or local compressed gas systems. The operating gases must have the required purity.
- Work on compressed gas containers and systems may only be carried out by individuals with specialist knowledge and experience in compressed gas systems.
- Compressed air hoses and pressure reducers may only be used for the assigned gases.
- Pipes, hoses, screw connections and pressure reducers for oxygen must be kept free from grease.
- Check all pipes, hoses and screw connections regularly for leaks and externally visible damage. Repair leaks and damage without delay.
- Shut off the gas supply to the device prior to any maintenance and repair work on the compressed gas containers.
- After successful repair and maintenance of the components of the compressed gas containers or system, the device must be checked for proper operation prior to recommissioning.
- Unauthorized assembly and installation are not permitted!

#### 2.4.5 Handling of auxiliary and operating materials

The operator is responsible for the selection of substances used in the process as well as for their safe handling. This is particularly important for radioactive, infectious, poisonous, corrosive, combustible, explosive and otherwise dangerous substances.

When handling hazardous substances, the locally applicable safety instructions and instructions in the safety data sheets from the manufacturers of the auxiliary and operating materials must be complied with.

When operating the solids module, granulated magnesium perchlorate is used as desiccant.

- When handling magnesium perchlorate, there is a risk of fire due to contact with highly flammable substances!
- Avoid generating dust and inhaling dust when filling the glass tube with the desiccant. Wear suitable personal protective equipment (respiratory mask, safety goggles, protective gloves).

Quartz glass wool is used in the combustion tube, in the halogen trap and in the drying tube.

- Quartz glass wool irritates the respiratory tracts. Avoid the formation of dust when working with quartz wool.
- Work under an extractor or wear a respiratory mask.
- Caution when handling glass and ceramic parts. Risk of breakage and therefore risk of injury!

#### 2.4.6 Safety instructions – maintenance and repair

The device is generally maintained by the customer service department of Analytik Jena or specialist personnel trained and authorized by them.

Unauthorized maintenance can damage the device. For this reason, only the activities described in the user manual in the "Maintenance and care" chapter may be performed by the operator.

- Only clean the exterior of the device with a slightly moistened, non-dripping cloth. Use only water and, if required, customary surfactants.
- Maintenance work and the replacement of components (removal of the combustion tube, cleaning of the dust trap, replacement of the particle filter) must only be carried out after a sufficiently long cooling down phase.
- Prior to maintenance or repair work, the power and gas supplies must be disconnected (unless stated otherwise) and the solids module must be vented!
- Use only original spare parts, wear parts and consumables. They have been tested and ensure safe operation. Glass part are wear parts and are not subject to the warranty.

### 2.5 Behavior during emergencies

- If there is no immediate risk of injury, switch off the device and the connected system components immediately in hazardous situations or in the event of an accident and disconnect the power plugs from the power outlets.
- Close the gas supply as soon as possible after switching off the devices.

## 3 Function and setup

### 3.1 Function and measuring principle

The solids module can be used to analyze samples (up to 3000 mg) in the form of pieces, chips, paste and liquid. The larger the sample amount, the less impact does an uneven sample structure have on the analysis result.

The samples are introduced into the hot zone of the combustion tube by means of sample boats. The samples are introduced as follows:

- manually using a loading tool
- with the FPG 48 autosampler (for the multi N/C 2100S duo and multi N/C 3100 duo modular measuring systems).

Large sample amounts with a high content of organic carbon compounds are covered with quartz sand to prevent an explosive combustion.

The sample is combusted completely in the oxygen flow. The measuring gas is sucked out of the combustion tube and through the connected analyzer by means of an integrated pump.

A dust trap and a particle filter installed at the outlet of the combustion tube clean the measuring gas of dust, ash and dirt. A drying tube also cleans and dries the measuring gas. Corrosive gases that form during the combustion are removed from the measuring gas by means of the halogen trap. Hydrogen fluoride (HF), however, is not removed. The measuring gas is then introduced into the detector in the connected analyzer. The pump ensures a stable flow through the solids module to the detector.

In the combustion tube, the pyrolysis and oxidation of the sample takes place in the oxygen flow at high temperatures.

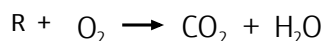

R Carbonic substance

The carbon dioxide content in the measuring gas is detected in the NDIR detector (non-dispersive infrared absorption detector) of the connected analyzer (see analyzer user manual).

#### Measuring methods

The solids module is used to determine the following parameters as sum parameters:

- TC: Total Carbon
- TOC: Total Organic Carbon

With a separate manual TIC solids module, the total inorganic carbon (TIC) can also be determined.

#### TC analysis

During the TC analysis the total carbon contained in the sample, i.e. organic and inorganic bound carbon as well as elemental carbon is detected.

#### TOC analysis

When determining the TOC concentration using the **direct method**, hydrochloric acid (HCl, 10 %) is added to the solids sample in the sample boat to remove the inorganically bound carbon. To this end the acid is added in drops until no more gas development is noticeable. The required acid volume depends on the weighed sample amount and the sample matrix. To be on the safe side, some concentrated hydrochloric acid is added (approx. 2 drops).



The inorganic carbon compounds react with acid to form carbon dioxide (CO<sub>2</sub>). Most of the gas dissipates immediately. The rest escapes when drying the sample in the drying cabinet. The wet sample with added acid is dried in the drying cabinet (e.g., at 105 °C for at least 3 h).

The pretreated sample can then be examined in the combustion furnace for organically bound carbon. A rest of hydrogen chloride always escapes from the samples in the combustion furnace. However, the corrosive gas can be removed from the measuring gas stream by means of the halogen trap.

TOC determination using the **differential method** (indirect method) takes place via two separate carbon measurements of the same sample. In this method, TC and TIC are determined one after the other. The total carbon (TC) is measured as described.

To determine the TIC, a separate module (manual TIC solids module) is available.

The total organic carbon (TOC) is calculated from the difference between TC and TIC:  
TOC = TC – TIC.

## 3.2 Layout

The solids module is a compact benchtop device with permanently installed main components. The safe operation of the solids module includes additional accessories (sample boats, loading tools) that must be made available prior to combustion.

The multiWin control and analysis program is used to control the solids module and analyze the measurements.

All components of the solids module to be operated or maintained by the user can be reached via the front and the right removable side panel.

The solids module consists of the following main components:

- Components for sample preparation
- Gas supply and hose system
- Combustion system
- Components for measuring gas drying and cleaning
- Electronic component
- Indicator and control elements, connections

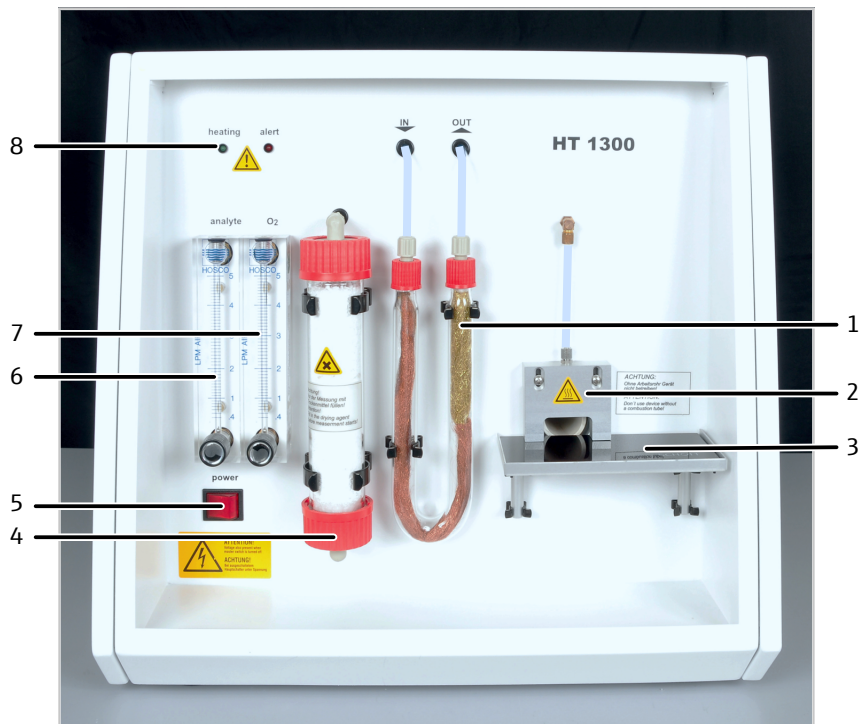

Fig. 1 Front view of the solids module

- |   |   |
|---|---|
| 1 Halogen trap                                  | 2 Gas sluice with oxygen connection and combustion tube |
| 3 Sample table (here: with ceramic glass plate) | 4 Drying tube   |
| 5 Main switch                                   | 6 "analyte" rotameter (suction flow)                    |
| 7 "O <sub>2</sub> " rotameter (oxygen flow)     | 8 Indicator elements                                    |

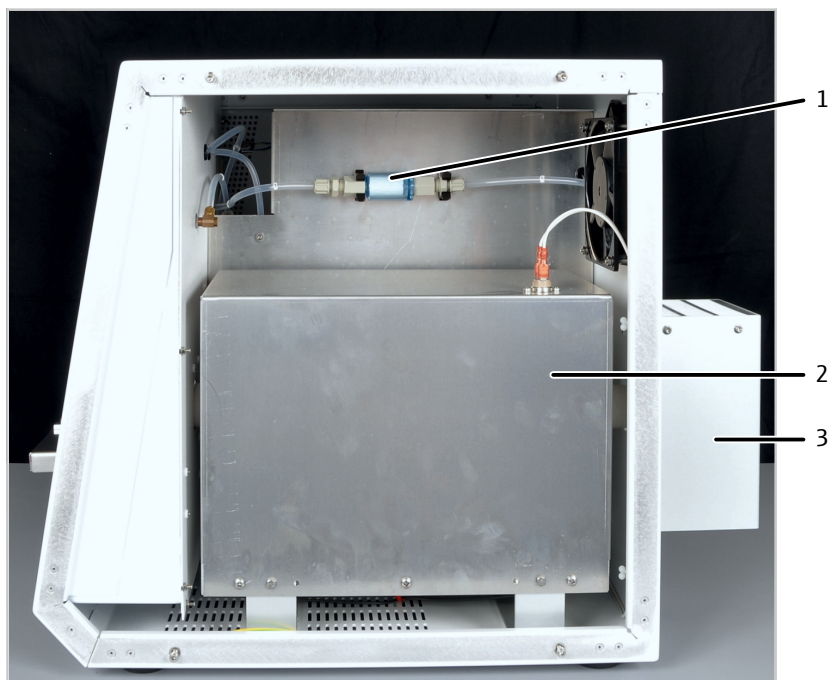

Fig. 2 Lateral view right (side panel removed)

- |                                    |                     |
|------------------------------------|---------------------|
| 1 Particle filter                  | 2 Combustion system |
| 3 Contact guard over the dust trap |                     |

## Sample preparation

Manual sample supply in the solids module takes place directly via ceramic sample boats. The sample amount for solid, powder, paste, slurry and liquid samples is up to 3000 mg.

For automated solids analysis with the multi N/C 2100S duo and multi N/C 3100 duo modular measuring systems, the solids module is coupled to the FPG 48 sampler. The sampler can feed up to 48 samples in ceramic boats into the solids module in succession.

The carrier and combustion gas is supplied into the combustion tube via an open gas sluice.

## Gas supply and hose system

The connection between the individual components is made with labeled hoses. The encircled numbers and letters in the hose diagram correspond to the labels on the hoses in the solids module.

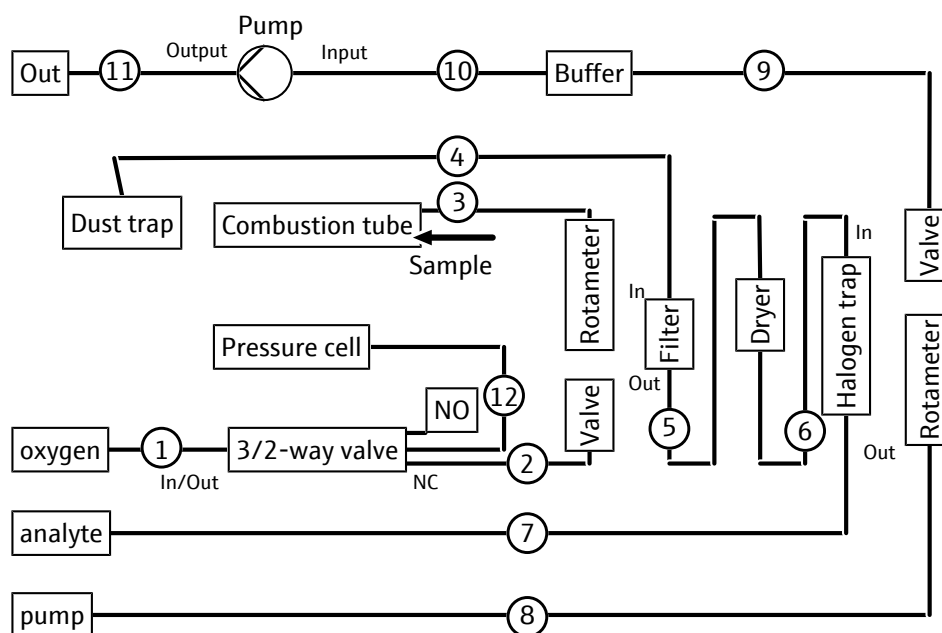

**Fig. 3** Hose diagram of the solids module

The gas flows for the measuring gas and the combustion gas are set manually via the rotameters on the front of the device.

The integrated control unit controls the suction flow of the combustion gas and the suction flow of the pump for the measuring gas transport through the analyzer. The control unit switches the pump on automatically if the actual temperature differs by less than 50 °C from the target temperature. If the actual temperature deviates by more than 50 °C from the target temperature, the pump is switched off.

The suction flow is set to approx. 1.7 l/min by means of the valve at the "analyte" rotameter and needs to be checked regularly at the solids module by the user. Dust deposits in the dust trap and the particle filter and used-up desiccant can reduce the oxygen flow. The user will therefore need to readjust the suction flow at the needle valve or perform maintenance, such as replacing the desiccant, from time to time.

The oxygen flow must be set to 2.2 l/min at the "oxygen" rotameter approx. 5 min before starting the analysis. The oxygen flow always has to be 0.5 l/min higher than the suction flow.

## Combustion system

The combustion system is behind the right side panel of the solids module.

The combustion furnace is a resistor-heated horizontal furnace for digestion temperatures of 900 to 1300 °C.

The ceramic combustion tube (reactor) serves as reaction chamber. The furnace heats the combustion tube up to the set temperature. A temperature controller monitors the heating, keeps the temperature at the target value and to some degree compensates for the aging of the heating rods.

The combustion tube is connected to gas supply and discharge lines. A gas sluice is fitted in front of the front opening of the combustion tube. A dust trap is fitted at the rear end of the combustion tube.

A fan cools the interior to prevent heat build-up. The combustion furnace is cooled automatically.

#### Measuring gas drying and cleaning

The solids module is equipped with the following components for drying and cleaning the measuring gas:

- Dust trap
- Particle filter
- Drying tube
- Halogen trap

The dust trap is located at the rear of the solids module. At the outlet of the combustion tube the dust trap calms the measuring gas flow. Coarse combustion particles, especially metal oxides in metallic samples, deposit there.

The particle filter has been installed behind the right-hand side panel. After cleaning in the dust trap, it removes fine dust, ash and dirt particles from the measuring gas.

The drying tube is located at the front. It consists of a glass tube that is filled with a special desiccant. The precleaned measuring gas is aspirated through the filled glass tube. In addition to moisture, the dryer retains particles, so that neither water nor dust enter the detector system of the analyzer.

A halogen trap is installed in the measuring gas path downstream of the dryer. The halogen trap removes interfering substances from the measuring gas and thus protects the detector in the analyzer. The U-tube is filled with copper wool and brass wool. The filling trap has to be renewed at the latest when half of the copper wool or the brass wool is discolored.

#### Electronic component

The electronic component is located behind the left-hand side panel of the solids module. The electronic component implements the power supply and control of the individual components and the communication with the control and analysis software.

### 3.3 Connection

#### Indicator elements

The lamps above the rotameters indicate various states or faults of the solids module.

#### Switches, interfaces

The main switch for switching the solids module on and off is located at the front below the rotameters.

The mains connection is located at the rear of the device. The interface for connecting a data cable to the analyzer ("temp. Control") is located on the left of the backplate (viewed from the front). The mains connection is below it.



**Fig. 4 Connections on the backplate of the solids module**

- 1 Analyzer interface
- 2 Mains connection
- 3 Measuring gas outlet "OUT"
- 4 Oxygen inlet "O<sub>2</sub>"
- 5 Pump connection "pump"
- 6 Measuring gas connection "analyte"

Gas and pump connections

The connections are arranged at the bottom of the backplate:

Connection	Label	Remark
Oxygen inlet	oxygen	The carrier gas oxygen is transported to combustion and the gas sluice through this connection.
Measuring gas outlet	OUT	This outlet remains free.
Measuring gas connection	analyte	The measuring gas is transported to the "analyte" connection at the analyzer through this connection.
Pump connection	pump	Connection to the "pump" connection at the analyzer (to suck in the measuring gas)

### 3.4 Layout of multi N/C 2100S duo and multi N/C 3100 duo

The multi N/C 2100S duo and multi N/C 3100 duo modular measuring systems enable the determination of the total carbon content (TC) and of the content of organically bound carbon (TOC) of liquid and solid samples. The user can easily switch between liquid and solid operation. A device conversion is not necessary. Up to 48 solid samples with a net weight up to 3000 mg can be analyzed fully automated.

In addition, an optional nitrogen detector (ChD or CLD) can be used to determine the nitrogen content of liquid samples.



**Fig. 5 multi N/C 2100S duo (linear layout)**

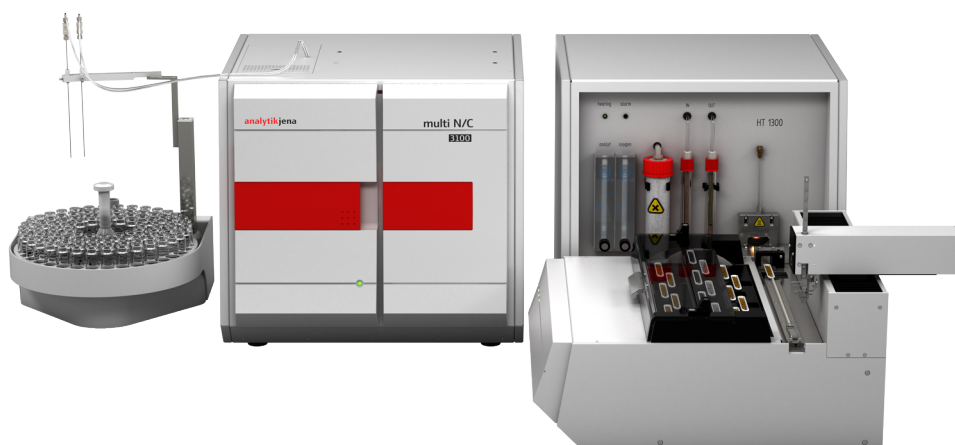

**Fig. 6 multi N/C 3100 duo (angular layout)**

The modular measuring systems consist of the following components:

- multi N/C 2100S or multi N/C 3100 analyzer
- HT 1300 solids module
- FPG 48 solids autosampler
- AS 60 liquid autosampler (for multi N/C 2100S duo) or AS vario ER liquid autosampler (for multi N/C 3100 duo)

The solids module is placed to the right of the analyzer. The solids module can be set up with the front side or with its left side facing forward. The result is either a linear or an angular layout.

The operation of the analyzer and the liquid sampler is described in detail in the operating instructions for the respective analyzer. Observe the information on switching between liquid and solid operation in these operating instructions (→ "Preparing the device for measurement with automatic sample introduction" 32).

FPG 48 solids sampler

The sampler provides space for 48 sample boats. The sampler takes up the boats from the boat carousel automatically and transfers them into the combustion furnace of the solids module. The transfer is computer-controlled.

The user can set a stopping position and the feed speed in the method parameters. After the measurement, the sampler transfers the boats back to the boat carousel.

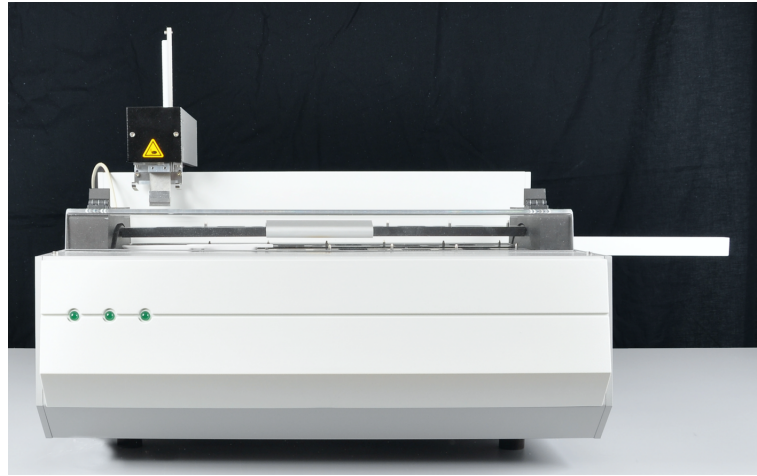

**Fig. 7** FPG 48 solids sampler

The sampler comes with height-adjustable feet, so that the height can be optimally adapted to the solids module.



## 4 Installation and commissioning

### 4.1 Environmental conditions

The laboratory atmosphere has to be as free of organic carbon compounds, nitrogen oxides and dust as possible and free of drafts and corrosive vapors. Do not place the device directly next to doors or windows.

Smoking is prohibited in the operating room of the solids module.

- This laboratory device is designed for indoor use.
- Do not use the device in wet and damp environments. Keep the device surface clean and dry.
- Avoid direct sunlight and radiation from heaters onto the device. If necessary, provide air conditioning.
- Place the device on a heat-resistant and acid-resistant surface.
- Do not locate the device near sources of electromagnetic interference.
- Avoid mechanical shocks and vibrations.
- Do not use the device in explosion-hazard environments.
- Never cover the right-hand side panel and the air vents with other devices or installations!
- Keep a safety distance of at least 5 cm from the back and the right side of the device to other devices or walls.

Environmental conditions

Temperature range	10 to 35 °C
Humidity during operation	Max. 90 % at 30 °C
Air pressure	0.7 to 1.06 bar
Temperature during storage	5 to 55 °C
Humidity during storage (use desiccant)	10 to 30 %

### 4.2 Power and gas supply



#### WARNING

##### Danger due to electrical voltage

- Only connect the device to a properly grounded socket which complies with the voltage indicated on the device's rating plate.
- Do not use an adapter in the feeder.

The device operates on single-phase alternating current.

The installation of the electrical equipment in the laboratory must comply with the DIN VDE 0100 standard. At the connection point, an electrical current in accordance with the standard IEC 60038 must be available.

Power supply to the solids module

Power supply	230 V ± 10 %
Frequency	50/60 Hz
Fuses	10 A H



Typical average power consumption	700 VA
Maximum power consumption	1000 VA
Analyzer interface	RS 232

To use the solids module in an area with mains voltages of 115 V, 120 V, 127 V, connection to two phases is possible. Contact Analytik Jena GmbH+Co. KG if required. This installation may only be performed by the customer service department of Analytik Jena GmbH+Co. KG or by specialist personnel authorized and trained by Analytik Jena GmbH+Co. KG.

## FPG 48 sampler power supply

Power supply	100 to 240 V ( $\pm 10\%$ )
Frequency	50 to 60 Hz
Maximum power consumption	30 VA
Analyzer interface	RS 232

## Solids module gas supply

The operator is responsible for the gas supply with connections and pressure reducers. Connection hoses (outer diameter: 6 mm, inner diameter: 4 mm) are included in the delivery.

Gas supply (purity)	Oxygen ( $\geq 2.5$ )
Inlet pressure	400 to 600 kPa
Gas consumption	<ul style="list-style-type: none"> <li>▪ 180 l/h</li> <li>▪ 2.2 l/min</li> </ul>
<ul style="list-style-type: none"> <li>▪ Total (maximum)</li> <li>▪ Oxygen flow</li> </ul>	

### 4.3 Device layout and space requirements

The required space depends on all the components that make up the measuring station. Provide sufficient space for all components of the multi N/C 2100S duo and multi N/C 3100 duo modular measuring systems.

Component	Dimensions (width x height x depth)	Weight
HT 1300 solids module	510 x 470 x 550 mm	22 kg
multi N/C 2100S duo total (at least)	1865 x 970 x 650 mm	95 kg
With the following components:		
Basic device multi N/C 2100S	513 x 464 x 550 mm	30 kg
AS 60 sampler	510 x 500 x 400 mm	9 kg
HT 1300 solids module	510 x 470 x 550 mm	22 kg
FPG 48 sampler	500 x 460 x 650 mm	20 kg
multi N/C 3100 duo total (at least)	2215 x 550 x 650 mm	85 kg
With the following components:		
Basic device multi N/C 3100	513 x 464 x 550 mm	30 kg
AS vario ER sampler	350 x 470 x 400 mm	15 kg
HT 1300 solids module	510 x 470 x 550 mm	22 kg
FPG 48 sampler	500 x 460 x 650 mm	20 kg

- The HT 1300 solids module is placed to the right of the analyzer. The solids module can be set up with the front side or with its left side facing forward.
- If the left side of the solids module points to the front: Maintain a distance of 200 mm between the analyzer and the solids module because of the heat radiated by the two devices.
- The FPG 48 solids sampler is placed in front of the solids module.
- The liquid sampler (AS 60, AS vario ER) is placed onto or to the left of the analyzer.

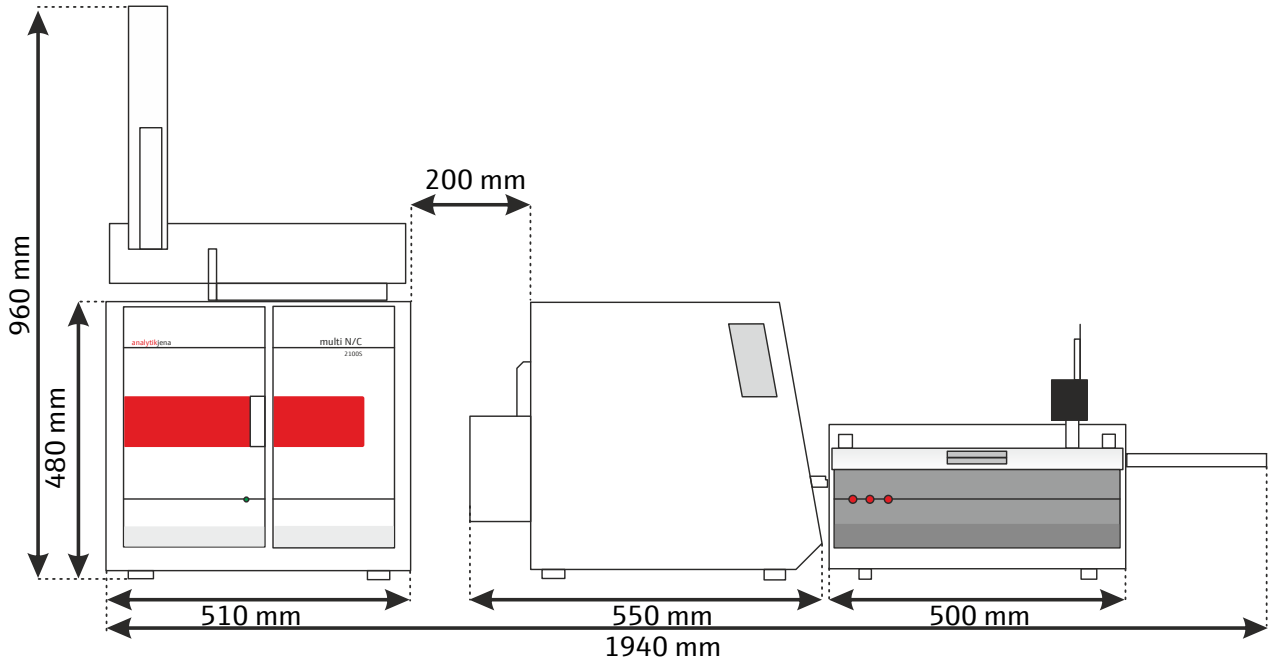

Fig. 8 Space required for multi N/C 2100S duo

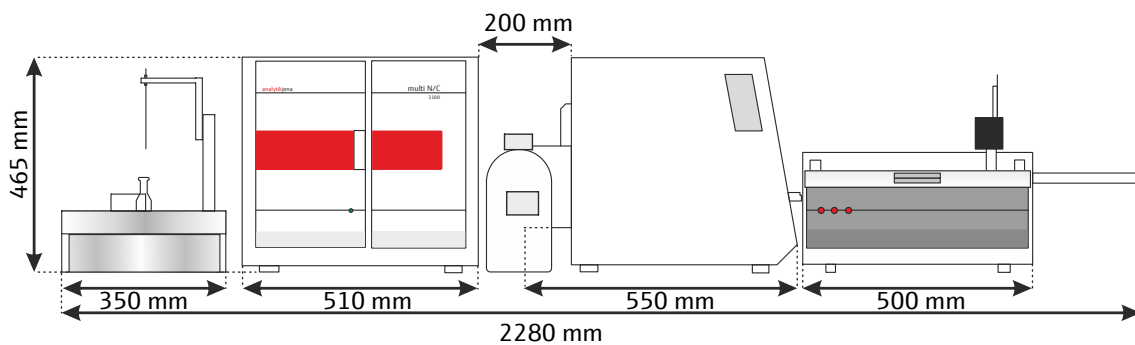

Fig. 9 Space required for multi N/C 3100 duo

#### 4.4 Unpacking and setting up the device

The device will be delivered directly to the final device location by a transportation company. The delivery by this company requires the presence of a person responsible for device installation.

It is imperative that all persons designated to operate the device are present during the briefing given by the service technician.

The device may only be set up, installed and repaired by the customer service department of Analytik Jena or by persons authorized by Analytik Jena.

When installing and commissioning your device, observe the information in the "Safety instructions" section. Compliance with these safety instructions is a requirement for the error-free installation and the proper functioning of your measuring station. Observe all warnings and instructions that are attached to the device itself or displayed by the control and analysis program.

To ensure trouble-free operation, please make sure that the installation conditions are observed.

#### 4.4.1 Setting up and connecting the solids module



### CAUTION

#### Risk of explosion

- Only fill the combustion tube with quartz wool.
- Do not use cotton wool. Cotton wool may lead to an explosive combustion, resulting in the destruction of the combustion tube and the device. This may lead to injuries.



### NOTICE

#### Damage to the electronics due to condensation







Significant temperature differences can lead to the formation of condensation which can damage the device's electronics.

- After long-term storage or transport in a colder environment, allow the device to acclimatize at room temperature for at least one hour before switching it on.



### NOTICE

#### Risk of damage to the sensitive electronics

- Only connect the device and the other components to the power grid when they are switched off.
  - Only connect and disconnect electrical connection cables between the system components when the system is switched off.
- 
- ▶ Remove the solids module from its packaging and place it in its intended location.  NOTICE! Keep the original packaging for future transportation!
  - ▶ Fill the lower end of the combustion tube with quartz glass wool. Install the combustion tube in the solids module together with the dust trap. Connect the gas hose to the dust trap (→ "Installing the combustion tube"  44).  CAUTION! Quartz wool irritates the respiratory tracts.
  - ▶ Fill the drying tube with magnesium perchlorate and attach it to the front of the solids module (→ "Replacing the desiccant"  41).  WARNING! Do not store magnesium perchlorate near combustible and highly flammable materials. Wear protective clothing and avoid dust formation when handling it.
  - ▶ Fill the halogen trap with copper and brass wool and insert it into the clamps on the front (→ "Replacing the halogen trap"  40).

- ▶ Attach the sample table to the front in front of the opening of the combustion tube.
  - To do so, push the sample table into the four clamps in front of the gas sluice.
  - Align the sample table such that the table has the same height as the inner lower edge of the combustion tube.



**Fig. 10 Sample table for manual and automatic sample introduction**

- ▶ Connect the IEC connection cable to the mains connection on the rear of the solids module. Insert the power plug of the connection cable into a grounded socket.
- ▶ Connect the connection hose for the oxygen supply to the pressure reducer of the gas supply and to the "oxygen" gas connection on the rear of the device. Set an inlet pressure of 400 to 600 kPa at the pressure reducer.
- ▶ Connect the solids module and the analyzer via the gas connections:
  - The multi N/C 3100/multi N/C 3100 duo is equipped with a solids valve assembly in the analyzer. Connect the solids module and the analyzer via the following connections:
    - "analyte" connection at the solids module to "analyte" connection on the backplate of the analyzer
    - "pump" connection at the solids module to the "pump" connection at the backplate of the analyzer
  - The multi N/C 2100S/multi N/C 2100S duo has the solids valve assembly attached to the rear of the analyzer. Connect the solids module and the valve assembly via the following connections:
    - "analyte" connection at the solids module to "from HT 1300" connection at the valve assembly
    - "pump" connection at the solids module to "to pump HT 1300" connection at the valve assembly
- ▶ Connect the serial data cable included in the delivery to the interface (CLD/HT) at the backplate of the analyzer. Connect the other end of the cable to the RS 232 interface of the solids module.
 

If the measuring station includes a nitrogen detector and a solids module: Connect the two modules to the interface (CLD/HT) at the backplate of the analyzer via a serial switch box.



**Fig. 11 Connections on the backplate of the solids module**

- |                              |                                      |
|------------------------------|--------------------------------------|
| 1 Analyzer interface         | 2 Mains connection                   |
| 3 Measuring gas outlet "OUT" | 4 Oxygen inlet "O <sub>2</sub> "     |
| 5 Pump connection "pump"     | 6 Measuring gas connection "analyte" |

**Gas and pump connections of the multi N/C 2100S duo**

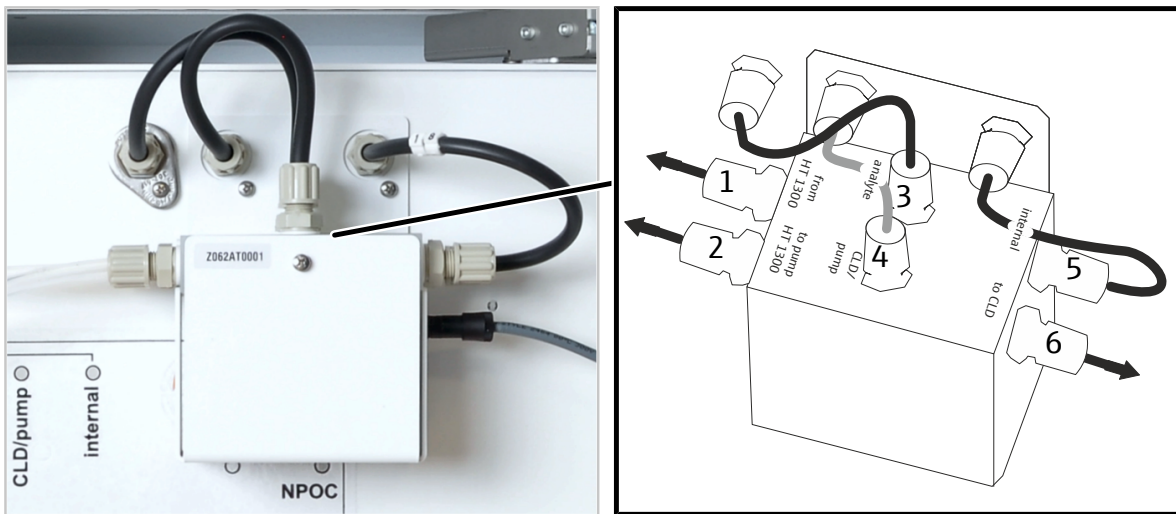

**Fig. 12 Valve assembly at the rear of the multi N/C 2100S duo**

- |                             |                               |
|-----------------------------|-------------------------------|
| 1 "from HT 1300" connection | 2 to pump HT 1300" connection |
| 3 "analyte" connection      | 4 "CLD/pump" connection       |
| 5 "internal" connection     | 6 "to CLD" connection         |

The connections on the valve assembly are arranged as follows:

Connection	Label	Remark
Measuring gas connection	from HT 1300	The measuring gas is transported from the solids module to the valve assembly through this connection.
Pump connection	to pump HT 1300	Connection of the valve assembly to the "pump" connection at the solids module (to suck in the measuring gas)
Measuring gas connection	analyte	The measuring gas is transported from the valve assembly to the "analyte" connection at the analyzer through this connection.

Connection	Label	Remark
Pump/CLD connection	CLD/pump	This connection is used to connect the pump or the CLD detector to the analyzer via the valve assembly.
Measuring gas connection to the NDIR detector	internal	Through this connection, the measuring gas is transported from the valve assembly to the "internal" connection at the analyzer and from there to the NDIR detector (only for liquid methods).
Measuring gas connection	to CLD	Through this connection, the measuring gas is transported from the valve assembly to the CLD detector for optional TN detection.

#### 4.4.2 Installing and adjusting the sampler



#### CAUTION

##### Risk of burns at the hot furnace

- Switch the solids module off and allow it to cool down before installing the sampler.



#### CAUTION

##### Risk of crushing at the FPG 48 sampler

The autosampler arm, the gripper and the boat carousel move during activation and initialization.

- Keep an adequate distance from the sampler to avoid having your hands crushed.



#### NOTICE

##### Risk of damage to the sensitive electronics

- Only connect the device and the other components to the power grid when they are switched off.
- Only connect and disconnect electrical connection cables between the system components when the system is switched off.

Installing the sampler

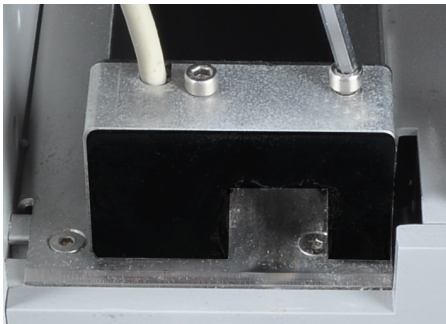

- ▶ Slide the boat sensor onto the short guide rail of the sampler from the left.
- ▶ Using the two hexagon socket screws tighten the boat sensor.

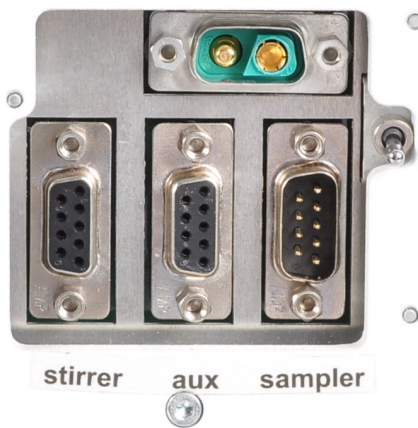

- ▶ Connect the boat sensor to the "aux" connection at the rear of the sampler.
- ▶ Place the sampler to the right of the solids module.
- ▶ Plug the cable on the low voltage side of the table power supply into the connection at the rear of the autosampler. Connect the power supply to the mains.
- ▶ Plug the protective conductor into the connection at the rear of the analyzer.



- ▶ Position the sampler to the right of the solids module.
- ▶ Connect the data cable supplied to the "sampler" interface at the rear of the sampler. Connect the other end of the cable to the serial switch box via interface A.
  - Connect interface B on the switch box to the serial interface of the liquid sampler via a data cable.
  - Connect the Input/Output interface on the switch box to the serial "sampler" interface on the rear of the analyzer. The analyzer has only one "sampler" interface. Both samplers (for solid and liquid operation) are connected to the analyzer via the switch box.

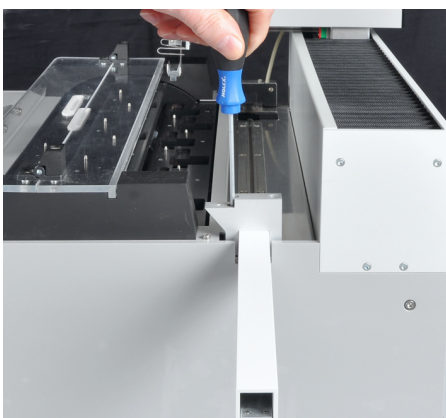

- ▶ Attach the cover for the long sliding rod to the sampler with the two hexagon socket screws on the right on the right-hand side of the guide rail.





- ▶ Insert the long sliding rod into the cover.
- ▶ Place the ceramic hook into the guide rail of the autosampler.
- ▶ Place the sliding rod onto the hook until the pin engages in the slot.

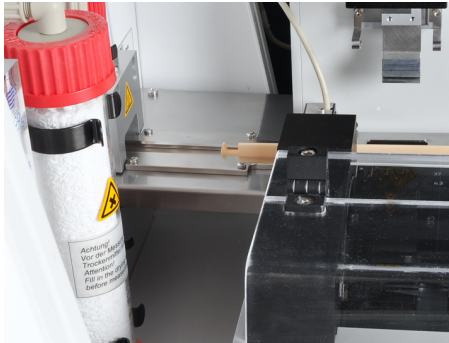

- ▶ Align the sampler on the solids module in such a manner that the hook can be guided into the combustion tube in the guide rail in a straight manner.
- ▶ If necessary, adjust the feet of the sampler so that the guide rail is at the same height as the sample table.

Adjusting the sampler

Align the gripper of the sampler arm towards the following positions using the software.

- Position 1 (on the boat carousel)
- Sliding position (cut-out in the sliding rod)
- ▶ Start the analyzer, the solids module and the sampler.
- ▶ Start the multiWin software and initialize the analyzer.
- ▶ Select **Instrument | Sampler Alignment**. A window with the same name opens.

multiWin - Alignment - sampler

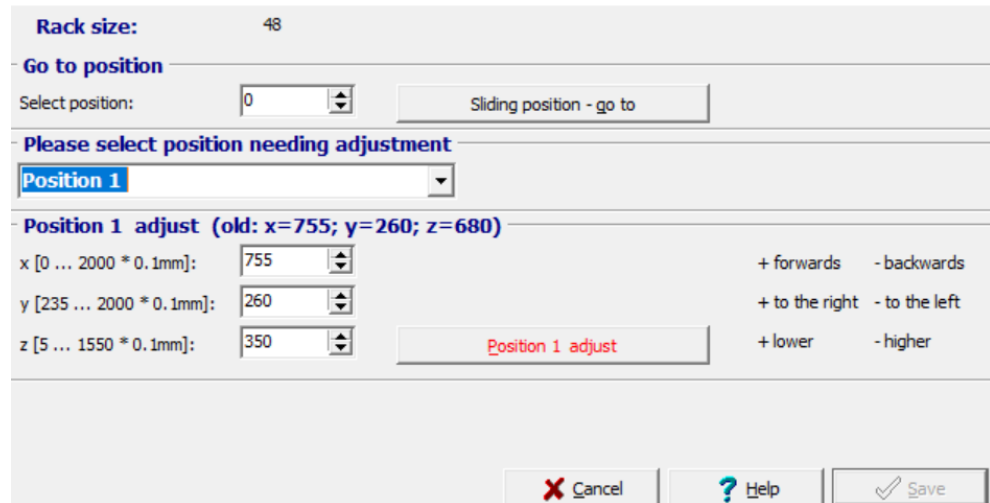
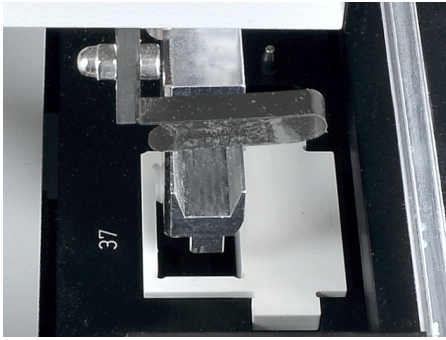
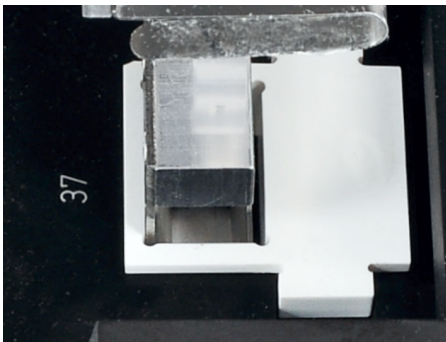

Fig. 13 Adjust Sampler





- ▶ Place the adjustment aid into the boat position to be adjusted on the rack (here position 37).
- ▶ In the **Please select position needing adjustment** list, select **Position 1** and then click on **[Position 1 adjust]**. The sampler arm moves above the left-hand boat position.
- ▶ Check that the gripper is centered above the opening of the adjustment aid and can enter the opening without obstruction. In most cases, the preset x and y values only need to be changed slightly. If necessary, correct the alignment in x and y direction via the input fields.
- ▶ For coarse adjustment, use the preset z value of 350. This prevents the gripper impacting hard with the autosampler.
- ▶ Check the changes by clicking on **[Position 1 adjust]**.



- ▶ Adjust the lowering depth of the gripper: For fine adjustment, set the z value to 680. Lower the gripper until it is only a few millimeters below the boat tray. This helps prevent the boat from gliding off the gripper when it is taken up.
- ▶ Check the changes by clicking on **[Position 1 adjust]**. Save the final position by pressing the corresponding button.

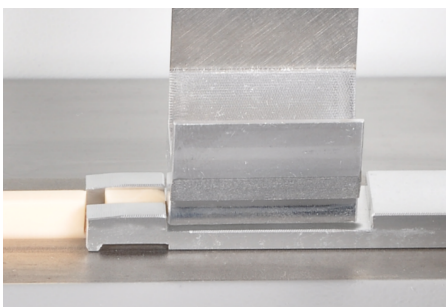

- ▶ Place the ceramic hook and sliding rod against the stop plate of the sampler.
- ▶ In the **Sampler Alignment** window, select **Sliding position** from the list and then click on **[Sliding position adjust]**. The sampler arm moves above the sliding position.

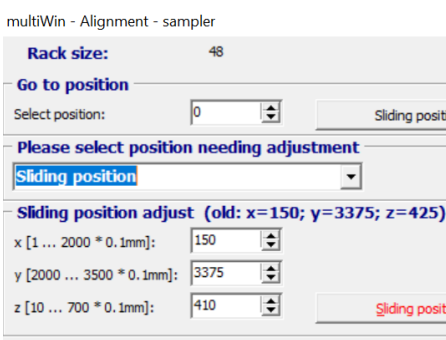

- ▶ Adjust the position in the cut-out in the sliding rod via the input fields. In most cases, the preset only need to be changed slightly. The gripper must be adjusted flush right and centered in the cut-out. The gripper must hover approx. 1 mm above the cut-out. The sampler arm must not exert any pressure on the sliding rod.
- ▶ Set the new position by clicking on **[Sliding position adjust]**.
- ▶ Repeat the process until the adjustment is correct. Save the final position by pressing the corresponding button.
  - ✓ The sampler has now been installed and adjusted.

## 5 Operation

### 5.1 Switching the device on



#### NOTICE

##### Risk of device damage due to depleted copper wool

Damage to optical and electronic components of the analyzer due to aggressive combustion products when the copper wool in the halogen trap is depleted!

- Only use the device with an operational halogen trap!
- Replace the complete filling of the halogen trap when half of the copper wool or brass wool is discolored!



#### NOTICE

##### Risk of sooting

In the event of incomplete combustion, there is a risk of sooting of the combustion tube and the hose system. Dirty hoses lead to incorrect measurements.

- Ensure that the oxygen flow is always 0.5 l/min higher than the suction flow of the pump.

Check before switching on:

- A combustion tube is present in the combustion furnace.
- The gas supply is connected with an inlet pressure of 400 to 600 kPa.
- The halogen trap is connected, filled with copper and brass wool and still usable.
- The dryer is connected, filled with desiccant and still usable.
- The hoses in the solids module are connected and in good working order.
- The data cable and the connection hoses to the analyzer are connected.

### 5.2 Preparing the device for measurement with manual sample introduction

Switch on the solids module as follows:

- ▶ Open the valve at the pressure reducer of the gas supply.
- ▶ Switch on the solids module at the main switch at the front.  
The fans are activated depending on the temperature.
- ▶ Switch on the connected analyzer.
- ▶ Start the multiWin program and initialize the device.
- ▶ In the **Options | Analyzer components** window (**Configuration | Edit options** menu command), activate the external solids module.
- ▶ Use the **Method | New** menu command to create a new method.
- ▶ In the method settings, activate **Horizontal Furnace** and **TC measurement**.
- ▶ Set the target temperature of the furnace.
- ▶ Alternatively, activate an existing method with settings for the solids module.

- ▶ Wait until the preheating time of the furnace has expired:  
approx. 15 to 20 min up to 1200 °C (starting at room temperature)  
approx. 30 to 35 min up to 1300 °C (starting at room temperature)
- ▶ Set the suction flow of the pump to 1.7 l/min at the "analyte" rotameter.
- ▶ Set the oxygen flow 0.5 l/min higher than the suction flow of the pump at the "oxygen" rotameter.
- ▶ Regularly check the suction flow at the solids module at the "analyte" rotameter and readjust the needle valve if necessary.

### 5.3 Performing a manual measurement



---

#### CAUTION

##### Risk of burns from touching hot sample boats

- Only touch the sample boats after they have cooled down.
- Always transport the sample boats with the loading tool.
- Allow the hot sample boats to cool down on a heat-resistant surface or on the table with the ceramic glass plate at the solids module.



---

#### NOTICE

##### Risk of overheating

Disconnecting the power plug disconnects the automatic cooling.

- Only switch off the solids module at the main switch after the measurements have been completed.
- Do not disconnect the power plug while the fan is still running.

---

Observe the following information during analysis:

- A max. 3000 mg of sample may be weighed in per measurement. Enter the sample net weight in the rack table and ensure that this sample amount really is combusted.
- Cover samples with a high content of organic carbon compounds with quartz sand to avoid explosive combustion.
- To determine the TOC using the direct method, add hydrochloric acid (HCl, 10 %) to the samples. Evaporate the acid in the drying cabinet (at least 3 h at 105 °C). Otherwise, high hydrogen chloride concentrations in the measuring gas will damage the device!
- The samples that are weighed into the sample boats should be as homogeneous and finely ground as possible.
- To save oxygen, shut off the oxygen supply at the "oxygen" rotameter during prolonged breaks between measurements. Set the oxygen supply back to a value that is 0.5 l/min higher than the suction flow at the "analyte" rotameter at least 5 min prior to the next measurement.
- If the pump does not suck out the measuring gases during a combustion, this may result in sooting of the combustion. Check and clean the combustion system.
- Only push the sample boat into the combustion tube when requested to do so by the multiWin program.

Perform a measurement as follows:

- ▶ Switch on the analyzer and the solids module and prepare them for a measurement with manual sample introduction.
- ▶ Weigh the finely ground sample into the sample boat.
- ▶ Start the measurement by clicking on **Start measurement**.
- ▶ Enter the **Sample ID** and, if necessary, a name for the analysis table.
- ▶ Define a **Sample type**.
- ▶ If necessary, enter explanations regarding the measurement by pressing the **[Comment]** button.
- ▶ Click on **[Start]** to open the **Measurement** window.
- ▶ Start the measurement by clicking on **[Start F2]**. Follow the instructions displayed on the screen.
- ▶ In the **Sample** window, enter the sample amount in [mg]. In the measurement window, in the **Signal** section, monitor the NDIR value. Wait until this value has passed a maximum. Then click on **[OK]** to close the **Sample** window. The program auto-zeroes the detector.
- ▶ Wait for the ready message of the analyzer. When **Please press [OK] to start integration and then feed sample into furnace!** is displayed, click on **[OK]**.
- ▶ Put the sample boat on the table with the ceramic glass plate. Push the sample boat into the hot zone of the combustion tube with the loading tool until the stop at the loading tool touches the front edge of the front edge of the tray.
- ▶ After the measurement output, once the measurement is complete, pull the sample boat back out of the combustion tube with the loading tool.
- ▶ Place the sample boat onto the ceramic glass plate or a prepared heat-resistant surface to cool down.
- ▶ Prepare and measure the next sample as described.
- ▶ Switch off the solids module at the main switch after the measurements have been completed. The fans continue running after switching off until a temperature of approx. 100 °C is reached.

## 5.4 Preparing the device for measurement with automatic sample introduction

(applies to the multi N/C 2100S duo and multi N/C 3100 duo modular measuring systems)

### Switching from liquid method to solids method

- ▶ Open the valve at the pressure reducer of the gas supply.
- ▶ Switch on the solids module at the main switch at the front. The fans are activated depending on the temperature.
- ▶ Switch on the connected analyzer. Switch on the sampler on the rear.
- ▶ Start the multiWin program and initialize the device.
- ▶ Open the **Options | Analyzer components** window via the **Configuration | Edit options** menu command.

- ▶ Activate the **External solids module** option.  
The software then automatically selects tray size 48. Confirm the settings with **[OK]**.

multiWin - Options

The screenshot shows the 'multiWin - Options' dialog box with the following settings:

- Furnace:**
  - internal furnace
  - external solid module
  - Maintenance interval: 1500
  - Number of analysis: 0
  - Combustions until maintenance interval: 1500
  - Reset button
- Sensors:**
  - C-measurement active
- Sampler:**
  - Rack size: 48 Solid

Fig. 14 Selecting the External solids module option

- ▶ If a liquid method was selected before, a message that the liquid method cannot be processed with the selected configuration appears. Confirm the message with **[OK]**. Wait for the analyzer to initialize.
- ▶ Use the **Method | New** menu command to create a new method or select an existing solids method.
- ▶ In the method settings, activate **Horizontal Furnace** and **TC measurement**.
- ▶ In the **System state** window, activate the solids sampler.  
The program asks the user to connect the correct sampler (FPG 48).

The screenshot shows the 'System state' window with the following data:

<b>System state</b>	
<b>NDIR</b>	<b>OK</b>
<b>C:</b>	661,6
<b>Gas flow</b>	<b>External</b>
<b>Temperature</b>	<b>OK</b>
<b>Furnace:</b>	1.178°C
<b>Sample introduction</b>	
<b>manual</b>	<b>Sampler (48)</b>

Fig. 15 Selecting the sampler in the System state window

- ▶ Switch the serial switch box to the solids sampler. To do so, set the rotary switch to A.

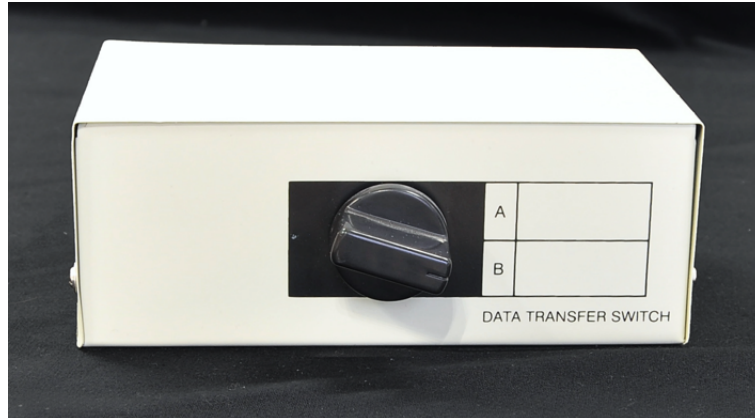

**Fig. 16 Switching the serial switch box**

- ▶ Confirm the setting.  
The program is closed automatically.
- ▶ Restart the program.
  - ✓ On the start screen, the device name is displayed with the addition "solid".
- ▶ Initialize the device.
- ▶ Create or load another solids method.  
When switching to automatic solid operation for the first time, a new solids method has to be created at this point for operation with the solids sampler. Methods for manual solid operation cannot be used here.
- ▶ Set the process parameters in the method.  
For the sampler: the first furnace position, the waiting time in this position and the feed speed  
For the solids module: the furnace temperature

multiWin - Load method

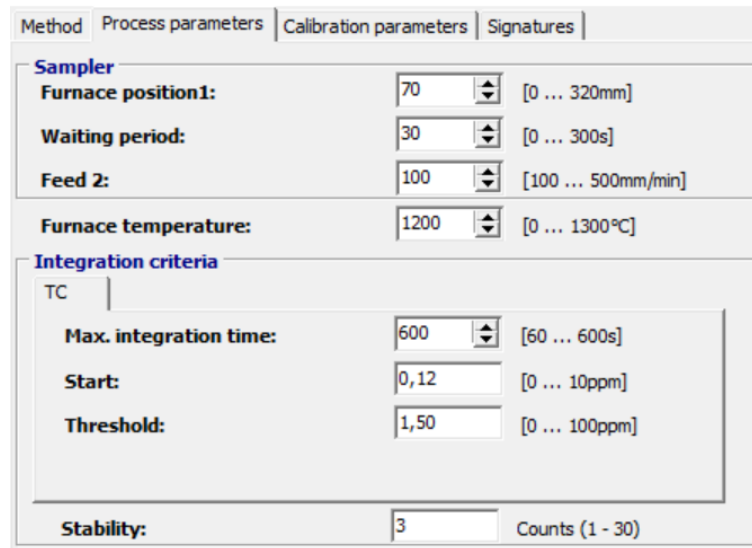

**Fig. 17 Setting the process parameters for the solids method**

- ▶ Wait until the preheating time of the furnace has expired:  
approx. 15 to 20 min up to 1200 °C (starting at room temperature)  
approx. 30 to 35 min up to 1300 °C (starting at room temperature)
- ▶ Set the suction flow of the pump to 1.7 l/min at the "analyte" rotameter.
- ▶ Set the oxygen flow 0.5 l/min higher than the suction flow of the pump at the "oxy-  
gen" rotameter.

- ✓ The device is ready for measuring solid samples as soon as the target temperature is reached and the gas flows have stabilized.
- The user has to check the suction flow regularly at the "analyte" rotameter on the solids module and, if necessary, readjust it at the needle valve.

### Switching from solids method to liquid method

- ▶ Start the multiWin program and initialize the device.
- ▶ In the **Options | Analyzer components** window (**Configuration | Edit options** menu command), activate the internal furnace option.
- ▶ If a nitrogen detector is present: Activate nitrogen measurements via the **N-measurement active** option.
- ▶ In the **Sampler** section, select the **Rack size** and the **Vessel size** for the liquid sampler. Define the syringe size for the multi N/C 2100S duo. Confirm the settings with **[OK]**.  
The program asks the user to connect the correct sampler.
- ▶ Switch the serial switch box to the liquid sampler. To do so, set the rotary switch to B.
- ▶ Confirm the setting.  
The program is closed automatically.
- ▶ Restart the program.
  - ✓ On the start screen, the device name is displayed (without the addition "solid").
- ▶ Initialize the device.
- ▶ Use the **Method | New** menu command to create a new method or select an existing liquid method.
- ▶ In the method settings, activate **Vertical Furnace** and, for example, TOC or TN as the method.
  - ✓ The device is ready for measuring liquid samples as soon as the target temperature is reached and the gas flows have stabilized.

## 5.5 Performing a measurement with automatic sample introduction



### CAUTION

#### Risk of crushing at the FPG 48 sampler

The autosampler arm, the gripper and the boat carousel move during activation and initialization.

- Keep an adequate distance from the sampler to avoid having your hands crushed.



### CAUTION

#### Risk of burns from touching hot sample boats or the hook

- Only touch the sample boats and the hook after they have cooled down.
- Allow the hot sample boats to cool down in the sampler.



## NOTICE

### Risk of overheating

Disconnecting the power plug disconnects the automatic cooling.

- Only switch off the solids module at the main switch after the measurements have been completed.
- Do not disconnect the power plug while the fan is still running.

Observe the following information during analysis:

- A max. 3000 mg of sample may be weighed in per measurement. Enter the sample net weight in the rack table and ensure that this sample amount really is combusted.
- Cover samples with a high content of organic carbon compounds with quartz sand to avoid explosive combustion.
- To determine the TOC using the direct method, add hydrochloric acid (HCl, 10 %) to the samples. Evaporate the acid in the drying cabinet (at least 3 h at 105 °C). Otherwise, high hydrogen chloride concentrations in the measuring gas will damage the device!
- The samples that are weighed into the sample boats should be as homogeneous and finely ground as possible.
- To save oxygen, shut off the oxygen supply at the "oxygen" rotameter during prolonged breaks between measurements. Set the oxygen supply back to a value that is 0.5 l/min higher than the suction flow at the "analyte" rotameter at least 5 min prior to the next measurement.
- If the pump does not suck out the measuring gases during a combustion, this may result in sooting of the combustion. Check and clean the combustion system.

Perform a measurement as follows:

- ▶ Switch on the analyzer, the solids module and the sampler and prepare the device system for a measurement with automatic sample introduction.
- ▶ Weigh the finely ground samples into the sample boats. Place the sample boats into the positions on the sampler.
- ▶ Start the measurement by clicking on **Start measurement**. The **Measurement start** window opens.
- ▶ Enter a name for a new analysis table in the window or select an existing analysis table by pressing **[Edit]**.
- ▶ Click on **[Start]** to open the **Current sample data** window.
- ▶ Open an existing rack table or enter the sample name in the **Sample ID** column in accordance with the sample rack assignment. It is also possible to enter the sample type and a unit. Then release the samples. Confirm the settings by pressing the button with the check mark.
- ▶ A query follows whether the rack table should be saved. If the settings are to be reused at a later time, save the rack table.
  - ✓ The rack table is closed.
- ▶ Start the measurement by clicking on **[Start F2]**. Follow the instructions displayed on the screen.
  - ✓ The samples are measured one after the other.
- ▶ Switch off the solids module at the main switch after the measurements have been completed.

The fans continue running after switching off until a temperature of approx. 100 °C is reached.



## 5.6 Measurement cancelation during automatic sample introduction

The boat sensor monitors the boat transfer from the sampler to the furnace. It detects the following fault conditions:

- Ceramic boat broken
- No ceramic boat on the hook

If one of the fault conditions occurs, the measurement is canceled immediately. An error message is issued in the software.

To resume a measurement after a cancelation:

- ▶ Acknowledge the error message in the software.
- ▶ If necessary, remove the broken parts of the boat from the furnace and the hook.
- ▶ Slide the ceramic hook manually to the stop plate.
- ▶ Reinitialize the device.

## 6 Troubleshooting

This section describes a number of device errors and analytic problems, some of which the user can rectify himself. Most of the device errors described are easy to identify. Most of the analytic problems lead to implausible measurement results. If the suggested solutions do not eliminate the errors/problems, and if such problems occur frequently, contact the customer service department of Analytik Jena.

Errors that are detected by system monitoring and displayed in the multiWin control and analysis program are described in the analyzer user manual.

### 6.1 Device error

Error	Possible cause	Remedy
Furnace does not heat	Communication error	<ul style="list-style-type: none"> <li>▪ Check mains connection</li> <li>▪ Check data transmission cable connection</li> </ul>
	Temperature set in the software is too low	<ul style="list-style-type: none"> <li>▪ Check and, if necessary, correct the set temperature</li> </ul>
Fans not running	Electronic faults	<ul style="list-style-type: none"> <li>▪ Report to customer service</li> </ul>
	Fan faulty	
	Fuse faulty	
No suction flow at the "analyte" rotameter	Pump not running	<ul style="list-style-type: none"> <li>▪ Report to customer service</li> </ul>
	Valve at the rotameter not open	<ul style="list-style-type: none"> <li>▪ Set the desired flow at the rotameter</li> </ul>
Suction flow too low	Desiccant in the drying tube used up	<ul style="list-style-type: none"> <li>▪ Refill desiccant</li> </ul>
	Dust trap or particle filter clogged	<ul style="list-style-type: none"> <li>▪ Clean the dust trap and replace the quartz wool plug in the combustion tube</li> <li>▪ Replace the particle filter</li> </ul>

The fans are only activated if the specified temperature in the interior of the solids module is exceeded. If the fans are not running and the interior temperature of the solids module exceeds a critical value, the combustion system is automatically switched off. In that case, the control and analysis program issues an error message.

## 6.2 Analytic problems

Error	Possible cause	Remedy
Scattering measurements	Inadequate sample preparation	<ul style="list-style-type: none"> <li>▪ Homogenize the samples</li> <li>▪ Weigh in a greater sample amount</li> </ul>
	Oxygen flow too low	<ul style="list-style-type: none"> <li>▪ Check the oxygen flow and increase it, if necessary</li> </ul>
	Boat blank value not taken into account	<ul style="list-style-type: none"> <li>▪ Take boat blank value into account</li> </ul>
No measured values/peaks	No sealing ring in the drying tube	<ul style="list-style-type: none"> <li>▪ Insert sealing ring and check system for leaks</li> </ul>
Low recovery	Desiccant too moist	<ul style="list-style-type: none"> <li>▪ Check desiccant, replace if necessary</li> </ul>
	Particle filter and measuring gas hoses sooted	<ul style="list-style-type: none"> <li>▪ Check filter and measuring gas hoses and clean if necessary</li> </ul>
	Gas connections not tight	<ul style="list-style-type: none"> <li>▪ Check the hose connections between the solids module and the analyzer and replace them if necessary</li> </ul>
Baseline drift (NDIR detector)	Detector signal not stable yet	<ul style="list-style-type: none"> <li>▪ Wait for warming-up phase</li> </ul>
	Oxygen flow too low	<ul style="list-style-type: none"> <li>▪ Increase the oxygen flow</li> </ul>
	Introduction of ambient air into the gas sluice	<ul style="list-style-type: none"> <li>▪ Avoid turbulent movement in front of the gas sluice</li> </ul>

# 7 Maintenance and care

## 7.1 Overview of maintenance work

Maintenance interval	Maintenance task
Daily	<ul style="list-style-type: none"> <li>Check the contents of the halogen trap for discoloration and replace the copper and brass wool if necessary</li> </ul>
	<ul style="list-style-type: none"> <li>Check the drying tube for moisture and discoloration</li> <li>Replace the contents of the drying tube if they are clumped or discolored.</li> </ul>
Weekly	<ul style="list-style-type: none"> <li>Clean the device</li> <li>Check the particle filter for soiling and replace the filter if it is discolored gray</li> </ul>
Monthly	<ul style="list-style-type: none"> <li>Check the hose connections for leaks</li> </ul>
Quarterly	<ul style="list-style-type: none"> <li>Check the combustion tube for soiling, cracks and damage</li> <li>Clean the combustion tube as necessary and at least every 12 months</li> <li>Check the dust trap for soiling after approx. 300 operating hours and clean it if necessary</li> </ul>

## 7.2 Replacing the halogen trap



### CAUTION

#### Skin and respiratory system irritation due to quartz wool

Quartz wool tends to form dust. Irritation can occur after breathing in or skin contact with this dust.

- Avoid the formation of dust when working with quartz wool.
- Wear protective clothing and gloves.
- Work under an extractor or wear a respiratory mask.



### NOTICE

#### Risk of device damage due to depleted copper wool

Damage to optical and electronic components of the analyzer due to aggressive combustion products when the copper wool in the halogen trap is depleted!

- Only use the device with an operational halogen trap!
- Replace the complete filling of the halogen trap when half of the copper wool or brass wool is discolored!



- ⇒ Replace the contents of the halogen trap when half of the copper wool is discolored.
- ▶ Remove the screw connectors from the halogen trap and remove the U-tube from the clamps.
  - ▶ Remove the quartz wool plugs.
  - ▶ Pull out the depleted copper wool or brass wool from the U-tube with a tweezers or a small hook.
  - ▶ Inspect the U-tube for cracks.
    - ▶ **i** NOTICE! Use only completely intact U-tubes.
  - ▶ If necessary, rinse the U-tube with ultrapure water and let it dry.
  - ▶ Fill the U-tube with new copper and brass wool. Replace the entire contents. Make sure that the copper and brass wool is not compacted too much, but also ensure that there are no larger hollow spaces.
  - ▶ Cover the copper and brass wool with quartz wool.
  - ▶ Carefully press the filled U-tube into the clamps.
  - ▶ Connect the IN hose to the gas inlet branch with copper wool and the OUT hose to the gas outlet branch with brass wool via the screw connectors.
  - ▶ Check the system for leaks.
    - ✓ The solids module is now ready for operation.

### 7.3 Replacing the desiccant



#### WARNING

##### Risk of fire

As a strong oxidant, magnesium perchlorate may intensify a fire.

- Do not store flammable and easily ignitable materials in the immediate vicinity of the desiccant.



#### CAUTION

##### Risk of irritations

Magnesium perchlorate causes severe irritation of the eyes, skin and respiratory tracts.

- Avoid generating dust during refilling.
- Wear protective clothing and observe all information and specifications from the safety data sheet while working with this hazardous substance.



## CAUTION

### Skin and respiratory system irritation due to quartz wool

Quartz wool tends to form dust. Irritation can occur after breathing in or skin contact with this dust.

- Avoid the formation of dust when working with quartz wool.
- Wear protective clothing and gloves.
- Work under an extractor or wear a respiratory mask.



- ▶ Carefully loosen the screw connections on the drying tube. Take care not to lose any of the seals.
- ▶ Remove the drying tube from the clamps.
- ▶ Completely replace the used quartz glass wool and desiccant.
- ▶ Clean the drying tube. If necessary, rinse the glass tube with ultrapure water and allow it to dry well.
- ▶ **i** NOTICE! Only refill completely dry glass tubes.
- ▶ Fill the lower end of the glass tube with quartz wool.
- ▶ Fill the glass tube with fresh desiccant (approx. 50 to 60 g).
- ▶ Screw the lower screw connection onto the glass tube. Take care not to lose the sealing ring.
- ▶ Push the glass tube into the clamps. Do not kink the hoses when doing so.
- ▶ Attach the upper screw connection to the glass tube.
- ▶ Check the system for leaks.
  - ✓ The solids module is now ready for operation.

## 7.4 Removing the combustion tube



## CAUTION

### Risk of burns

- Allow the device to cool down before removing the combustion tube, dust trap and particle filter (3 to 4 h).
- Set the furnace temperature to 20 °C in the multiWin program. Only quit the program and switch off the device after this. Otherwise there is a risk of burns when checking the system for leaks after installation.

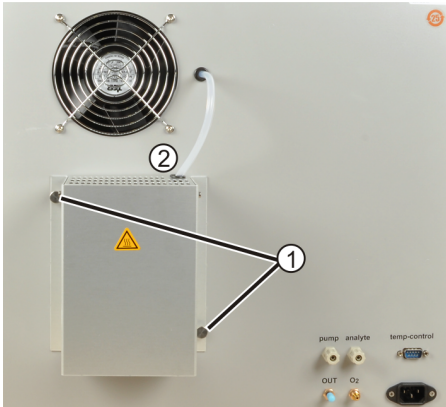

- ▶ Switch off the solids module at the main switch.
- ▶ When the device has cooled down, disconnect the power plug from the power outlet. Cut the gas supply.
- ▶ Unscrew the knurled head screws (1) from the dust trap contact guard.
- ▶ Remove the hose gland (2) from the slot in the contact guard. Remove the contact guard.

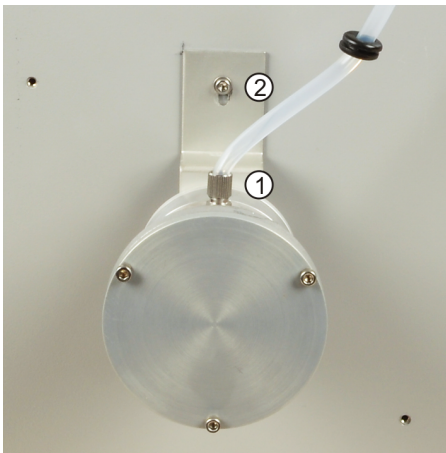

- ▶ Loosen the union nut (1) of the measuring gas hose on the dust trap. Disconnect the hose from the dust trap.
- ▶ Completely unscrew the hexagon socket screw (2) from the support bracket.

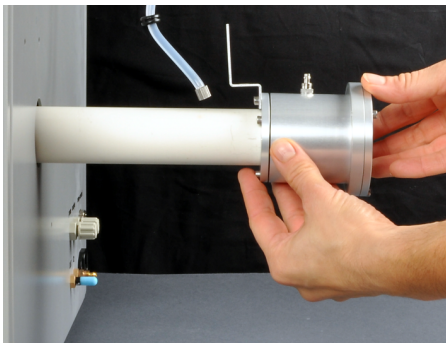

- ▶ Carefully pull the combustion tube with the dust trap out of the combustion furnace towards the rear, turning the combustion tube slightly. Take care that the tube does not get jammed when doing so.

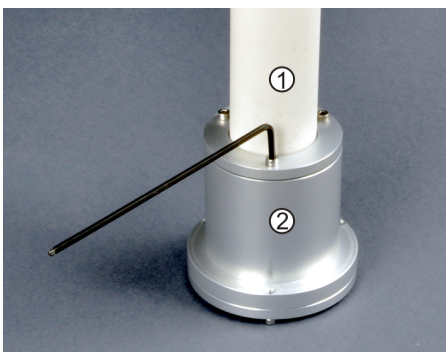

- ▶ For dismantling, place the combustion tube vertically onto a level surface with the dust trap pointing down.
- ▶ Loosen the three hexagon socket screws at the dust trap (2). Carefully turn the combustion tube (1) to pull it off the dust trap.



- ▶ Remove the used quartz glass wool from the combustion tube.
- ▶ Check the combustion tube for sooting, cracks and breakage. Only re-use intact combustion tubes.

## 7.5 Installing the combustion tube



---

### CAUTION

#### Risk of explosion

- Only fill the combustion tube with quartz wool.
  - Do not use cotton wool. Cotton wool may lead to an explosive combustion, resulting in the destruction of the combustion tube and the device. This may lead to injuries.
- 



---

### CAUTION

#### Skin and respiratory system irritation due to quartz wool

Quartz wool tends to form dust. Irritation can occur after breathing in or skin contact with this dust.

- Avoid the formation of dust when working with quartz wool.
  - Wear protective clothing and gloves.
  - Work under an extractor or wear a respiratory mask.
- 



---

### NOTICE

#### Operation without combustion tube will damage the device

- Only operate the solids module with the combustion tube installed.
- 

Observe the following information during installation:

- Re-use only intact and clean combustion tubes.
- Make sure that the quartz glass wool is positioned correctly.
- Make sure that the combustion tube is correctly positioned in the dust trap.

The quartz glass wool in the combustion tube retains light dust particles and soot particles generated by explosive combustions. If the quartz glass wool is sufficiently deep (8 to 10 cm) in the combustion tube, the retained residues can be combusted completely before they are extracted at the combustion tube outlet. Do not push the quartz glass wool too far towards the center of the combustion tube. Otherwise the quartz glass wool would clump together at very high temperatures.



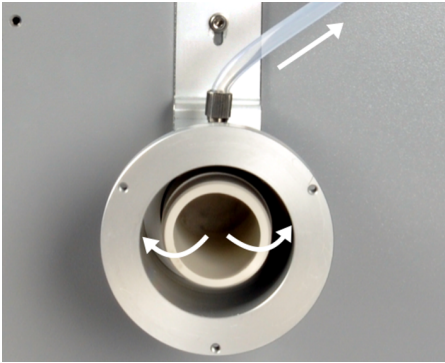

Do not insert the combustion tube too deep into the dust trap. If the combustion tube touches the bottom of the dust trap, the suction flow is obstructed. The dust trap clogs up with dust, which is indicated by a decreasing suction flow at the "analyte" rotameter. This results in analytic problems (results too low, no analyte signal).

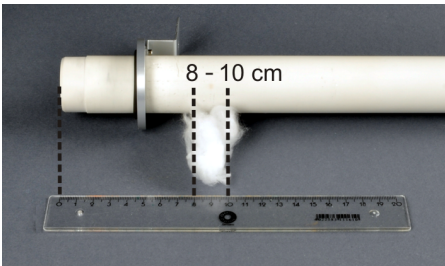

- ▶ Insert fresh quartz glass wool into the combustion tube:
  - Using a glass rod, push an approximately palm-sized amount of quartz glass wool from the tapered end into the combustion tube.
  - The quartz glass wool has to fill the entire cross section of the combustion tube at a depth of 8 to 10 cm.



- ▶ Slide the ring with the support bracket (1) and the seal (2) a few centimeters onto the combustion tube from the tapered end.

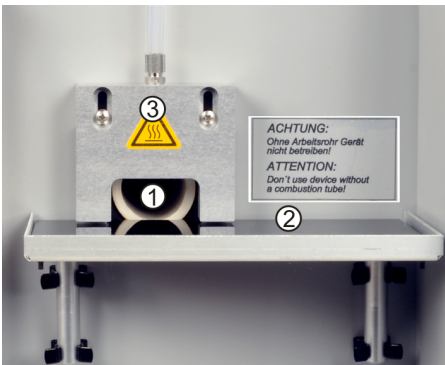

- ▶ Insert the combustion tube into the combustion furnace in such a manner that it is flush with the housing at the device front. A small gap has to remain between the combustion tube (1) and the ceramic glass plate (2), so that the combustion tube can expand as it heats up.
- ▶ If necessary, loosen the gas sluice (3) to install the combustion tube.



- ▶ Hold the support bracket against the housing.
- ▶ Mark the position for the sealing ring on the tube with a pencil.
- ▶ Remove the combustion tube from the furnace again.
- ▶ Slide the seal to the marked position.

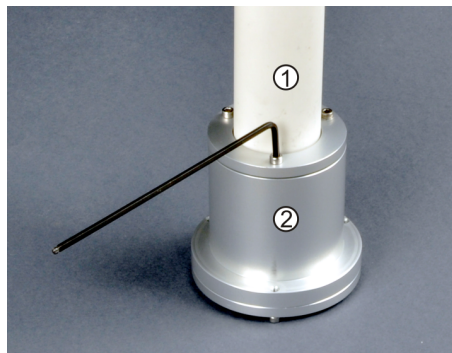

- ▶ To mount the combustion tube (1) to the dust trap (2), place the dust trap onto an even surface. Mount the combustion tube to the dust trap.
- ▶ Tighten the hexagon socket screws at the ring with the support bracket evenly. Only apply minimal force when doing so.

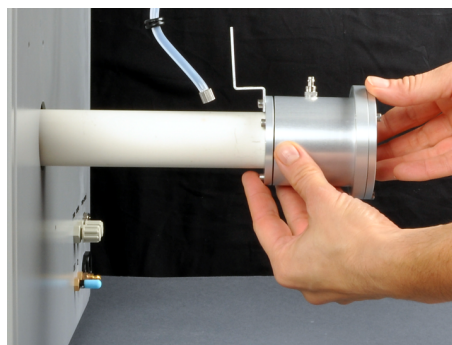

- ▶ Carefully slide the combustion tube with the mounted dust trap into the combustion furnace up to the stop. Take care that it does not get jammed!

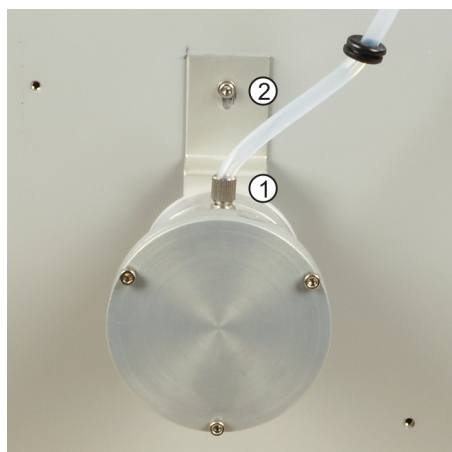

- ▶ Plug the measuring gas hose (1) onto the measuring gas connection at the dust trap. Tighten the union nut.
- ▶ Screw the hexagon socket screw (2) at the support bracket into the housing.



- ▶ Insert the hose gland of the measuring gas hose (2) into the slot in the contact guard. Attach the contact guard with the two knurled head screws (1).
- ▶ Check the system for leaks.
  - ✓ The solids module is now ready for operation.

## 7.6 Cleaning the dust trap



### CAUTION

#### Risk of burns

- Allow the device to cool down before removing the combustion tube, dust trap and particle filter (3 to 4 h).
- Set the furnace temperature to 20 °C in the multiWin program. Only quit the program and switch off the device after this. Otherwise there is a risk of burns when checking the system for leaks after installation.



- ▶ Switch off the solids module at the main switch.
- ▶ When the device has cooled down, disconnect the power plug from the power outlet. Cut the gas supply.
- ▶ Unscrew the knurled head screws (1) from the dust trap contact guard.
- ▶ Remove the hose gland (2) from the slot in the contact guard. Remove the contact guard.

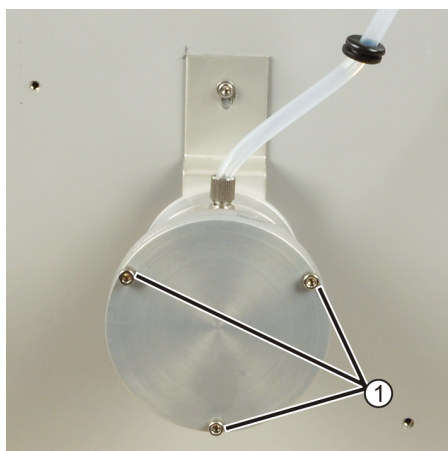

- ▶ Completely unscrew the hexagon socket screws (1) from the bottom of the dust trap.

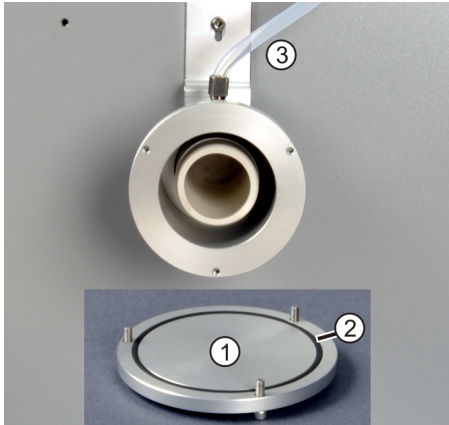

- ▶ Remove the bottom of the dust trap (1). Keep the sealing ring (2) in a safe place.
- ▶ Clean the dust trap and the bottom of the dust trap with a brush. Unscrew the measuring gas hose (3) and also clean it with the brush.
  - i** NOTICE! Do not clean the dust trap with cleaning agents or a moist cloth! Traces of cleaning agents or moisture lead to incorrect measurements.
- ▶ Place the bottom of the dust trap and the sealing ring on the dust trap. Tighten the hexagon screws evenly and moderately in a criss-cross pattern. Screw the measuring gas hose back on. Re-use only undamaged sealing rings!
- ▶ Push the hose gland of the measuring gas hose into the slot in the contact guard. Attach the contact guard with the knurled head screws.
- ▶ Check the system for leaks.

If combustion particles are visible in the dust trap, the particle filter also needs to be checked for soiling and replaced if necessary.

## 7.7 Replacing the particle filter



### CAUTION

#### Risk of burns

- Allow the device to cool down before removing the combustion tube, dust trap and particle filter (3 to 4 h).
- Set the furnace temperature to 20 °C in the multiWin program. Only quit the program and switch off the device after this. Otherwise there is a risk of burns when checking the system for leaks after installation.

Remove the particle filter as follows:

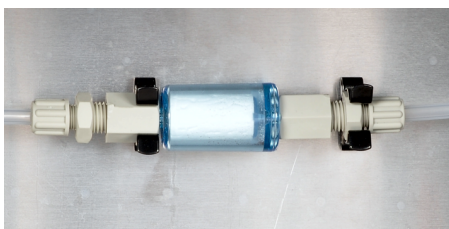

- ▶ Switch off the solids module at the main switch.
- ▶ When the device has cooled down, disconnect the power plug from the power outlet. Cut the gas supply.
- ▶ Open the right-hand side panel. Disconnect the ground connector when doing so. Store the side panel in a safe place.
- ▶ Remove the particle filter from the clamps.
- ▶ Loosen the plastic screw connections at the particle filter. Remove the particle filter.
- ▶ If discolored gray, replace the particle filter.

Install the particle filter as follows:

- ▶ Push the new particle filter firmly onto the plastic screw connections. Tighten the screw connections.
- ▶ Push the particle filter into the clamps. Ensure a tight seat!
- ▶ Plug the ground connector firmly into the right-hand side panel and reattach the side panel.
- ▶ Check the system for leaks.
  - ✓ The solids module is now ready for operation.

## 7.8 Checking the system for leaks

Most system leaks are detected because they lead to analytic problems such as a low recovery. It may not be possible to record any measured values.

System tightness can only be checked by visual inspection:

- ▶ Switch on the solids module.
- ▶ Open the oxygen supply at the pressure reducer.
- ▶ Check the system for leaks. To do so, first check the tight seat of the gas connections manually.
- ▶ Brush the gas connections with a strongly foaming soap solution. If foam bubbles form, the gas connection is not tight.
- ▶ Check all hose connections to the analyzer.

## 8 Transport and storage



### WARNING

#### Risk of damage to health due to improper decontamination

- Decontaminate the device professionally and document the cleaning measures before returning the device to Analytik Jena.
- The customer service department will send you the decontamination report when you register the return.



### CAUTION

#### Risk of burns from touching hot device components

- Allow the device to cool down before removing the combustion tube, dust trap and sample table (3 to 4 h).



### CAUTION

#### Risk of injury

Glass and ceramic parts can break easily. Therefore there is a risk of injury when handling them.

- Handle glass and ceramic parts particularly carefully.



### NOTICE

#### Risk of device damage due to unsuitable packaging material

- Only transport the device and its components in the original packaging.
- Empty the device completely and attach all transport locks before transporting the device.
- Add a suitable desiccant to the packaging to prevent damage from moisture.

### 8.1 Packing the solids module

- ▶ Switch off the solids module at the main switch. Switch off the gas supply and let the device cool down. Only disconnect the power plug from the power outlet when the device has cooled down.
- ▶ Disconnect all connections on the rear of the solids module.
- ▶ Remove the sample table from the clamps.
- ▶ Carefully loosen the red screw connections at the drying tube and remove the glass tube from the clamps. Slide a quartz glass wool plug into the hollow space above the desiccant.



**⚠ WARNING!** Do not store magnesium perchlorate near combustible and highly flammable materials. Wear protective clothing and avoid dust formation when handling it. Quartz wool irritates the respiratory tracts.

- ▶ Reattach the drying tube to the solids module. First tighten the lower screw connection, then the upper screw connection.
- ▶ Remove the combustion tube and the dust trap from the solids module for transport (→ "Removing the combustion tube" 📖 42).
- ▶ Screw the screws for attaching the dust trap and the contact guard back into the housing of the solids module.
- ▶ Retighten the hexagon socket screws at the dust trap.
- ▶ Carefully pack the accessories in their original packaging. Ensure that the combustion tube is packed break-proof.
- ▶ Pack the open hose end of the oxygen hose in a protective bag. Attach the bag to the housing with adhesive tape.
  - ✓ The solids module is securely packed for transport.

## 8.2 Transport

When transporting the device, observe the safety instructions in the "Safety instructions" section.

Avoid the following during transport:

- Impact and vibration  
Risk of damage due to shock, impact or vibration!
- Large temperature fluctuations  
Risk of condensation!

## 8.3 Moving the device in the laboratory



### CAUTION

#### Risk of injury during transport

Dropping the device poses a risk of injury and damage to the device.

- Proceed carefully when moving and transporting the device. Two persons are required to lift and carry the device.
- Grip the device firmly at the bottom with both hands and lift it simultaneously.

Observe the following when moving the device within the laboratory:

- Insufficiently secured components pose a risk of injury!  
Before moving the device, remove all loose parts and disconnect all connections from the device.
- For safety reasons, two persons are required to transport the device, one person on each side of the device.
- As the device does not have carrying handles, grip the device firmly with both hands at the lower end. Lift the device simultaneously.
- Observe the guide values and adhere to the legally mandated limits for lifting and carrying loads without auxiliary means.
- Observe the installation conditions at the new location.

## 8.4 Storage



---

### NOTICE

#### **Risk of device damage due to environmental conditions**

Environmental influences and condensation can destroy individual components of the device.

- Only store the device in air-conditioned rooms.
- Ensure that the atmosphere is free of dust and corrosive vapors.

---

If the device is not installed immediately after delivery or not required for longer periods, it should be stored in its original packaging. A suitable desiccant should be added to the equipment to prevent damage from moisture.

The requirements for the climatic conditions of the storage location can be found in the specifications.



## 9 Disposal

At the end of its service life, the device and its electronic components must be disposed of as electronic waste in accordance with the applicable regulations.

Waste water containing acids and samples occurs during device operation. Dispose of the neutralized waste in accordance with the legal requirements.

Desiccant

Neutralize the used-up desiccant (magnesium perchlorate) in a sodium thiosulfate solution with acidification. The desiccant decomposes into less hazardous reduction products (magnesium chloride). Dispose of the waste solution in accordance with the legal requirements.

Halogen trap

The halogen trap contains copper and brass. Contact the responsible institution (authority or waste disposal company). There you will receive the information regarding recycling or disposal.

## 10 Specifications

### 10.1 Technical data

#### HT 1300 solids module

##### Procedural data

Digestion principle	Oxidative combustion
Digestion temperature	900 to 1300 °C (or less if required)
Max. sample amount	3000 mg
Sample feed <ul style="list-style-type: none"> <li>▪ Manual operation</li> <li>▪ Automated operation</li> </ul>	<ul style="list-style-type: none"> <li>▪ Weighing in ceramic boats</li> <li>▪ Introduction of the ceramic boats by means of the FPG 48 sampler</li> </ul>
Gas supply (purity)	Oxygen ( $\geq 2.5$ )
Inlet pressure	400 to 600 kPa
Gas consumption <ul style="list-style-type: none"> <li>▪ Total</li> <li>▪ Analyte gas flow</li> </ul>	<ul style="list-style-type: none"> <li>▪ 180 l/h</li> <li>▪ 1.7 l/min</li> </ul>
Temperature control	<ul style="list-style-type: none"> <li>▪ Internal temperature controller</li> <li>▪ Control via an external PC and connected analyzer</li> </ul>
Operational readiness (preheating time of the furnace) <ul style="list-style-type: none"> <li>▪ Up to 1200 °C</li> <li>▪ Up to 1300 °C</li> </ul>	<ul style="list-style-type: none"> <li>▪ 15 to 20 min</li> <li>▪ 30 to 35 min</li> </ul>

##### Electrical variables

Power supply	230 V $\pm$ 10 %
Frequency	50/60 Hz
Fuses	10 A H
Typical average power consumption	700 VA
Maximum power consumption	1000 VA
Analyzer interface	RS 232

Only use original fuses from Analytik Jena!

##### General characteristics

Dimensions (W x H x D)	510 x 470 x 550 mm
Mass	22 kg

##### Environmental conditions

Temperature range	10 to 35 °C
Humidity during operation	Max. 90 % at 30 °C
Air pressure	0.7 to 1.06 bar
Temperature during storage	5 to 55 °C
Humidity during storage (use desiccant)	10 to 30 %

## FPG 48 sampler

### Electrical variables

Power supply	100 to 240 V ( $\pm 10\%$ )
Frequency	50 to 60 Hz
Maximum power consumption	30 VA
Analyzer interface	RS 232

### General characteristics

Dimensions (W x H x D)	500 x 460 x 650 mm
Mass	20 kg
Maximum number of samples	48

## multi N/C 2100S duo and multi N/C 3100 duo modular measuring systems

Modules of the measuring system: analyzer, liquid sampler, solids module, solids sampler

### General characteristics

multi N/C 2100S duo

Dimensions (W x H x D)	1865 x 970 x 650 mm
Mass	95 kg

multi N/C 3100 duo

Dimensions (W x H x D)	2215 x 550 x 650 mm
Mass	85 kg

## 10.2 Standards and directives

Protection class and protection type

The device is protection class I. The housing is protection type IP 20.

Device safety

The device complies with the following safety standards

- EN 61010-1
- EN 61010-2-081
- EN 61010-2-010

EMC compatibility

The device has been checked for transient emissions and noise immunity.

It meets the requirements for transient emissions according to

- EN 61326-1 (EN 55011 group 1, class B)

The device meets the requirements for noise immunity according to

- EN 61326-1 (requirements for use in a basic environment)

---

Environmental and ambient influences	<p>This device has been tested in environmental simulations under operation and transport conditions and is in accordance with the requirements in:</p> <ul style="list-style-type: none"><li>■ ISO 9022-2</li><li>■ ISO 9022-3</li></ul>
EU directives	<p>The device meets the requirements of the directive 2011/65/EU.</p> <p>The device is designed and tested in accordance with standards meeting the requirements of EU directives 2014/35/EU and 2014/30/EU. The device leaves the factory in a sound condition with regard to technical safety. To maintain this condition and to ensure safe operation, the user must strictly observe the safety and operating instructions contained in this operating manual. For accessories delivered with the device and system components from other manufacturers, the information provided in their respective operating manuals has priority.</p>
Guidelines for China	<p>The device contains substances subject to regulation (according to the directive GB/T 26572-2011). Analytik Jena guarantees that, if the device is used as intended, these substances will not leak within the next 25 years and therefore will not pose a threat to the environment or health within this time period.</p>

## Index of figures

Fig. 1	Front view of the solids module .....	14
Fig. 2	Lateral view right (side panel removed) .....	14
Fig. 3	Hose diagram of the solids module .....	15
Fig. 4	Connections on the backplate of the solids module .....	17
Fig. 5	multi N/C 2100S duo (linear layout) .....	18
Fig. 6	multi N/C 3100 duo (angular layout) .....	18
Fig. 7	FPG 48 solids sampler .....	19
Fig. 8	Space required for multi N/C 2100S duo .....	22
Fig. 9	Space required for multi N/C 3100 duo .....	22
Fig. 10	Sample table for manual and automatic sample introduction .....	24
Fig. 11	Connections on the backplate of the solids module .....	25
Fig. 12	Valve assembly at the rear of the multi N/C 2100S duo .....	25
Fig. 13	Adjust Sampler .....	28
Fig. 14	Selecting the External solids module option .....	33
Fig. 15	Selecting the sampler in the System state window .....	33
Fig. 16	Switching the serial switch box .....	34
Fig. 17	Setting the process parameters for the solids method .....	34